

sijingcheng

Aluminum

Industry

Foshan, China



Redefine the light luxury life

INTRODUCTION

Seeking truth is our foundation, innovation is our driving force!

The company is located in Shishan Town, Nanhai District, Foshan City, Guangdong Province, covering an area of more than 20,000 square meters and has thousands of tons of inventory warehousing and aluminum alloy products. The company has extrusion, spraying, and trading. The company provides one-stop services integrating independent research and development, production, and marketing. The company insists on surviving on quality and developing on innovation, and aims to provide customers with high-quality products and services. We uphold the attitude of heart-to-heart exchange, and use sincerity and care to make customers feel comfortable, worry-free, and assured!



More peace of mind



Safer



More interesting



Greener

FACTORY

DISPLAY



PRODUCT COLOR



Angel White



Enamel White

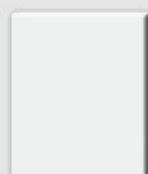

Pearl White



Crystal White



New Oxygen Ceramic Gray



Phantom Gray



Cream Gray



Silver Gray



Wood Color

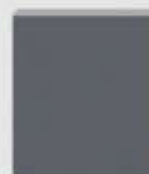

Porcelain Gray



PVDF Gray



Porcelain Silver Gray



Porcelain Silver Color



Moonlight Gray



Crystal Champagne Color



Flat Gray



Black Crystal Color



Khaki Brown



PVDF Coffee



New Oxygen Gray



Sandblasted Black



Black Color



Brushed Black



Wifa Gold



Red Wood



Brushed Gray



Crape Myrtle Color



Forest Wood Color



Walnut Color



Naturalism Return to Nature

DIRECTORY

35×08 Single Glass Extremely Narrow	05	40 Push-Pull Series	29	35 Medium Narrow Push-Pull	48
35×16 Single Glass Extremely Narrow	07	40 Extremely Narrow Swing Door	31	35 Medium Narrow Casement Series	50
35 Extremely Narrow	09	45 Extremely Narrow	33	35 Medium Narrow Casement Series General Diagram	52
35 Extremely Narrow Swing door	15	45 Push-Pull Series	36	Extremely Narrow and Medium Narrow Folding Series	54
35 Inward Opening Extremely Narrow	19	45 Extremely Narrow Swing door	39	60 Small Foldable Series	57
4010 Perfect Series	21	35 Partition Series	43	Folding Door Display	58
4012 Solid Extremely Narrow	23	3545 Medium Narrow Push-Pull	45	Integrated Frame Cover Series	59
40 Extremely Narrow Series	25	35 Medium Narrow Push-Pull	46	20. Minimalism	61



Minimalist Design

Breaking the boundaries and opening up a large field of vision, the extremely narrow door leaf design allows for a large landscape enjoyment.

Extra Long Service Life

Designed to be opened repeatedly 50,000 times (International 10,000 times), consistent with a service life of more than 20 years.

Safer To Use

The profile design adopts European standard hardware notches and connects multiple locking points to achieve a good anti-theft effect.



Color:



Angel White



Black Color



Silver Gray



Phantom Gray

Calculation Formula
(for reference only)

3508 two rails and two sash:
side seal = total height (YDL-828)

Upper and lower track = total width - 40

Flat section = total height - 80

Top and bottom = total width - 8/2

Glass: High = flat section - 16

Width = top and bottom - 16

Model: YDL-830

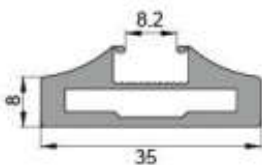

Name: flat section	Length: 4.8m
Thickness: *mm	Weight per meter: 0.55kg/m

Model: YDL-831

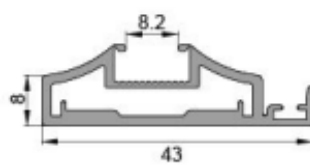

Name: hook section	Length: 4.8m
Thickness: 1.5mm	Weight per meter: 0.467kg/m

Model: YDL-832

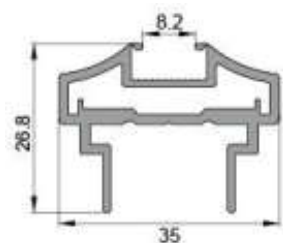

Name: top and bottom	Length: 6m
Thickness: 1.5mm	Weight per meter: 0.542kg/m

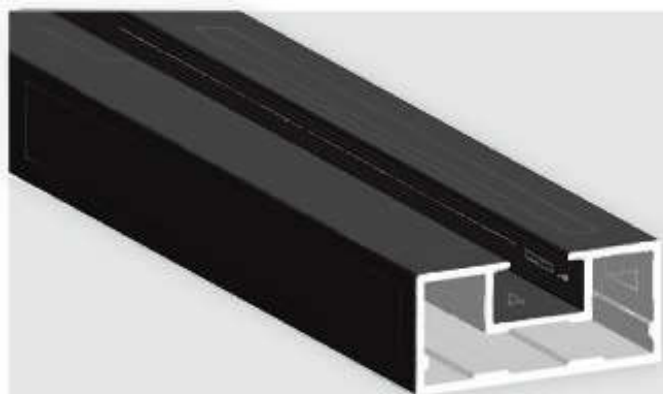

Color:



Angel White



Porcelain
Silver Color



Moonlight
Gray



Black Color



Model: YDL-825

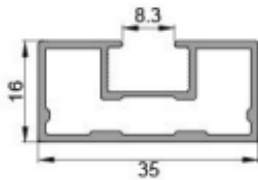

Name: flat section	Length: 4.8m
Thickness: 1.2mm	Weight per meter: 0.388 kg/m

Model: YDL-826

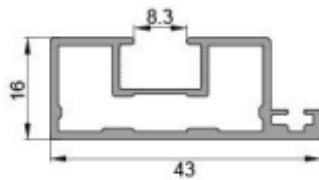

Name: hook section	Length: 4.8m
Thickness: 1.2mm	Weight per meter: 0.449 kg/m

Model: YDL-827

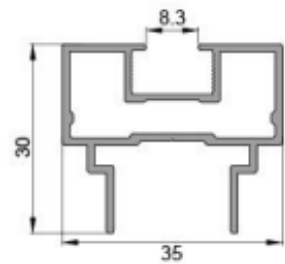

Name: top and bottom	Length: 6m
Thickness: 1.2mm	Weight per meter: 0.495 kg/m

Model: YDL-3515

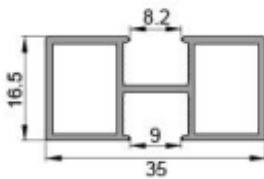

Name: middle horizontal	Length: 6m
Thickness: 1.1mm	Weight per meter: 0.349 kg/m

Model: YDL-3516

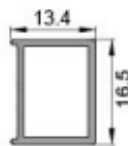

Name: self-adhesive middle horizontal	Length: 6m
Thickness: 1.1mm	Weight per meter: 0.159 kg/m

BRIGHT SPOT

Details witness quality



Rhombus Border

Craft Glass

Whole Aluminum Plate

Color:



Angel White



Porcelain Silver
Color



Silver Grey



Cream Grey



Moonlight Grey



Black Color



Phantom Gray



Wood Color

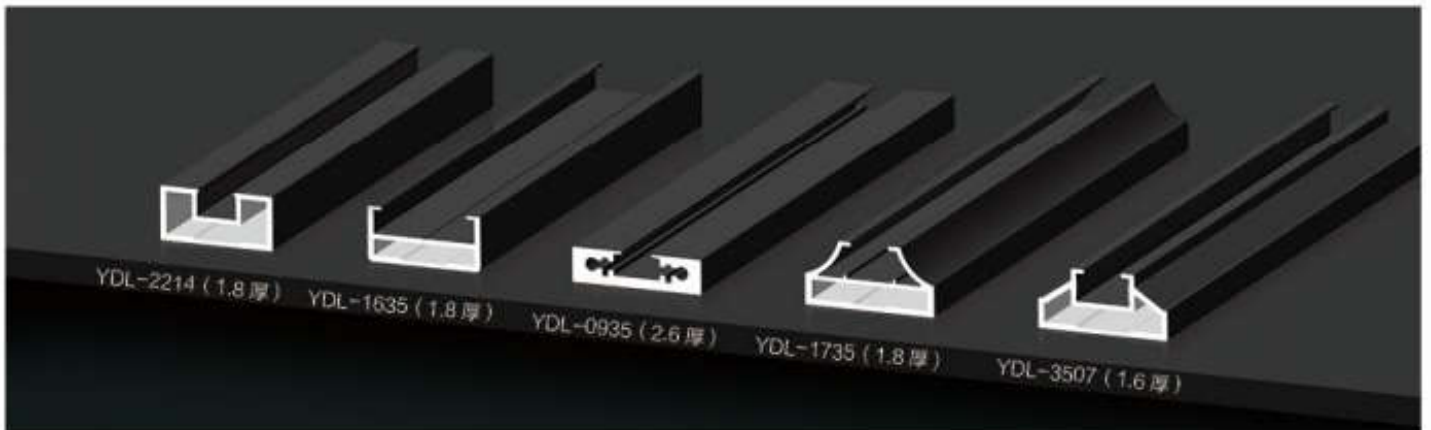

Model: YDL-2214

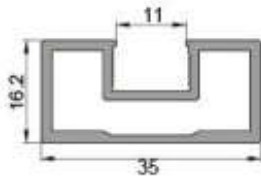

Name: flat section	Length: 4.8m
Thickness: 1.8mm	Weight per meter: 0.48 kg/m

Model: YDL-2215

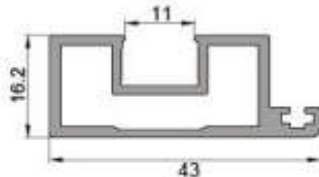

Name: hook section	Length: 4.8m
Thickness: 1.8mm	Weight per meter: 0.55 kg/m

Model: YDL-2216

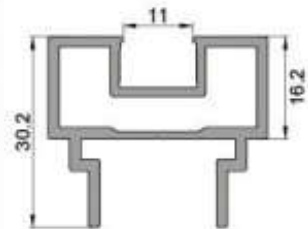

Name: top and bottom	Length: 6m
Thickness: 1.8mm	Weight per meter: 0.645 kg/m

Model: YDL-1635

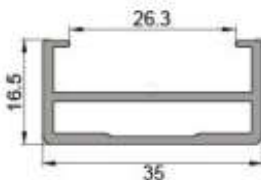

Name: flat section	Length: 4.8m
Thickness: 1.8mm	Weight per meter: 0.423 kg/m

Model: YDL-1636

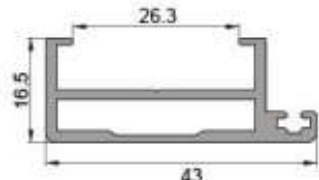

Name: hook section	Length: 4.8m
Thickness: 1.8mm	Weight per meter: 0.494 kg/m

Model: YDL-1637

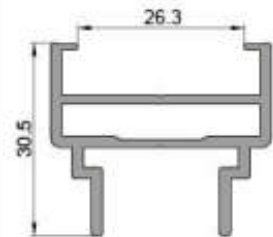

Name: top and bottom	Length: 6m
Thickness: 1.8mm	Weight per meter: 0.587 kg/m

Model: YDL-0935

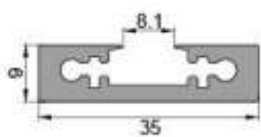

Name: flat section	Length: 4.8m
Thickness: 2.6mm	Weight per meter: 0.517kg/m

Model: YDL-0936

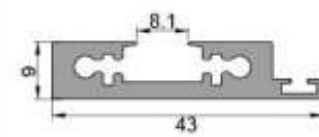

Name: hook section	Length: 4.8m
Thickness: 2.6mm	Weight per meter: 0.558kg/m

Model: YDL-0937

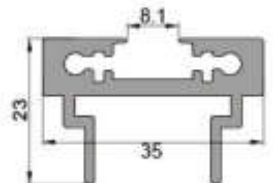

Name: top and bottom	Length: 6m
Thickness: 2.6mm	Weight per meter: 0.668kg/m

Model: YDL-1735

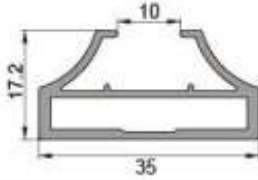

Name: flat section	Length: 4.8m
Thickness: 1.8mm	Weight per meter: 0.408kg/m

Model: YDL-1736

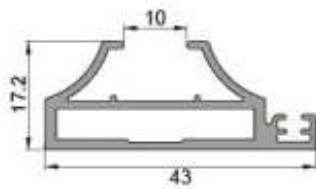

Name: hook section	Length: 4.8m
Thickness: 1.8mm	Weight per meter: 0.48kg/m

Model: YDL-1737

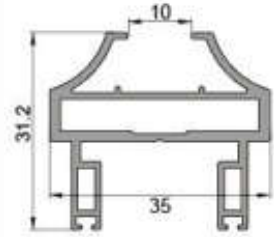

Name: top and bottom	Length: 6m
Thickness: 1.8mm	Weight per meter: 0.582kg/m

Model: YDL-1738

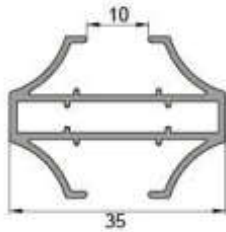

Name: middle horizontal	Length: 6m
Thickness: 1.1mm	Weight per meter: 0.447kg/m

Model: YDL-3507

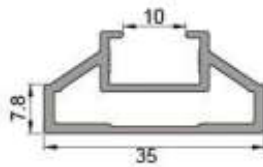

Name: flat section	Length: 4.8m
Thickness: 1.6mm	Weight per meter: 0.392kg/m

Model: YDL-3508

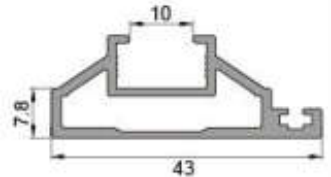

Name: hook section	Length: 4.8m
Thickness: 1.6mm	Weight per meter: 0.46kg/m

Model: YDL-3509

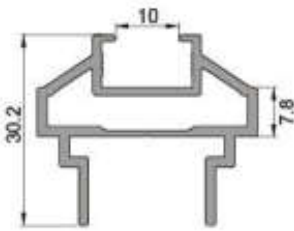

Name: top and bottom	Length: 6m
Thickness: 1.6mm	Weight per meter: 0.539kg/m

Model: YDL-3513

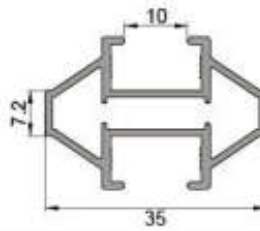

Name: middle horizontal	Length: 6m
Thickness: 1.1mm	Weight per meter: 0.422kg/m

Model: YDL-3514

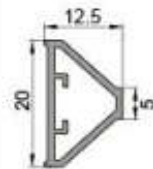

Name: self-adhesive middle horizontal	Length: 6m
Thickness: 1.1mm	Weight per meter: 0.167kg/m

Model: YDL-8426

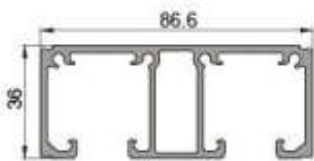

Name: double hanging rail	Length: 6m
Thickness: 2.0mm	Weight per meter: 1.82kg/m

Model: YDL-8427

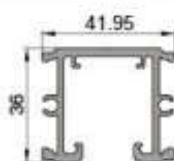

Name: single hanging rail	Length: 6m
Thickness: 2.0mm	Weight per meter: 0.972kg/m

Model: YDL-8428

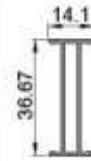

Name: hanging rail plug-in	Length: 6m
Thickness: 1.0mm	Weight per meter: 0.264kg/m

Model: YDL-291

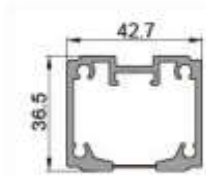

Name, single hanging rail	Length: 6m
Thickness: 2.0mm	Weight per meter: 1.06kg/m

Model: YDL-289

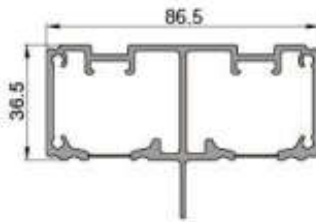

Name, double hanging rail	Length: 6m
Thickness: 2.0mm	Weight per meter: 2.02kg/m

Model: YDL-331

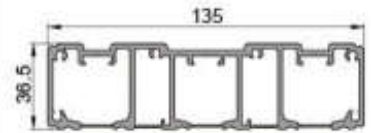

Name, three linkage hanging rail	Length: 6m
Thickness: 2.0mm	Weight per meter: 2.85kg/m

Model: YDL-290

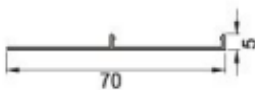

Name, rail cover	Length: 6m
Thickness: 1.0mm	Weight per meter: 0.203kg/m

Model: YDL-329

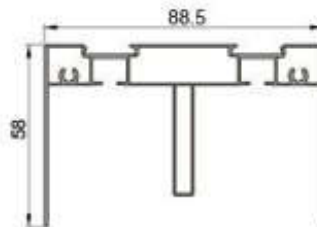

Name, double upper rail	Length: 6m
Thickness: 1.2mm	Weight per meter: 0.808kg/m

Model: YDL-326

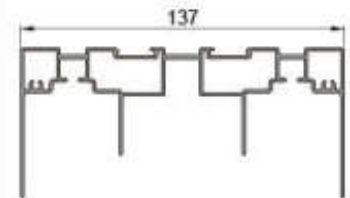

Name, three upper tracks	Length: 6m
Thickness: 1.2mm	Weight per meter: 1.91kg/m

Model: YDL-19073



Name, double lower rail	Length: 6m
Thickness: 1.0mm	Weight per meter: 0.435kg/m

Model: YDL-328

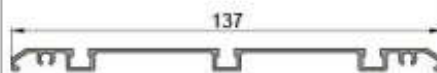

Name, three upper tracks	Length: 6m
Thickness: 1.2mm	Weight per meter: 0.665kg/m

Model: YDL-330A

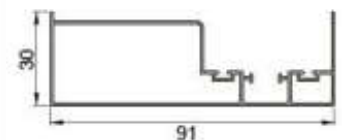

Name, single point edge seal	Length: 4.8m
Thickness: 0.9mm	Weight per meter: 0.693kg/m

Model: YDL-330

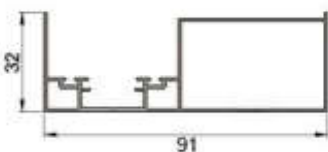

Name, single point edge seal	Length: 4.8m
Thickness: 1.0mm	Weight per meter: 0.729kg/m

Model: YDL-327

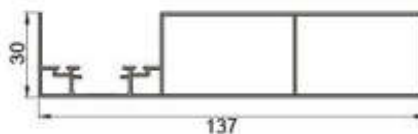

Name, single point three side sealing	Length: 4.8m
Thickness: 1.0mm	Weight per meter: 1.1kg/m

Model: YDL-327A

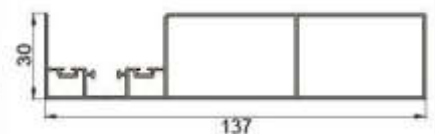

Name, single point three side sealing	Length: 4.8m
Thickness: 1.0mm	Weight per meter: 1.1kg/m

Model: YDL-1639

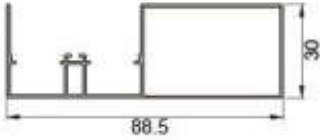

Name: double side seal	Length: 4.8m
Thickness: 1.0mm	Weight per meter: 0.677kg/m

Model: YDL-1641

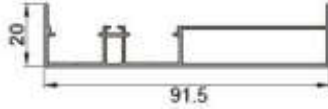

Name: flush double edge seal	Length: 4.8m
Thickness: 1.0mm	Weight per meter: 0.637kg/m

Model: YDL-1642

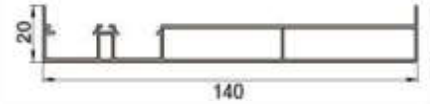

Name: flush double structure three side seal	Length: 4.8m
Thickness: 1.0mm	Weight per meter: 0.928kg/m

Model:YDL-820

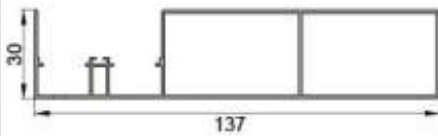

Name: 30 high side seal	Length:4.8m
Thickness:1.1mm	Weight per meter: 1.12kg/m

Model:YDL-828

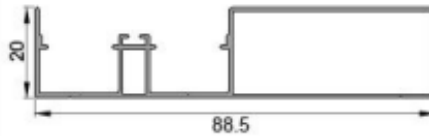

Name:20 high side seal	Length:4.8m
Thickness: 1.0mm	Weight per meter:0.6kg/m

Model:YDL-829

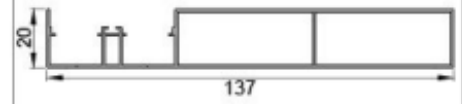

Name: 20 high side seal	Length: 4.8m
Thickness:1.1mm	Weight per meter: 1.0kg/m

Model: YDL-2226

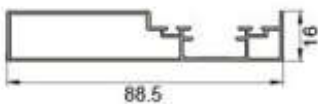

Name: ultra-narrow single point edge seal	Length: 4.8m
Thickness: 1.1mm	Weight per meter: 0.626kg/m

Model:YDL-2225

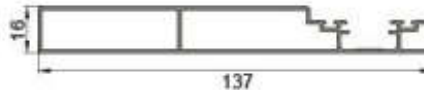

Name:Ultra-narrow single point three-side sealing	Length:4.8m
Thickness:1.1mm	Weight per meter:0.929kg/m

Model: YDL-292

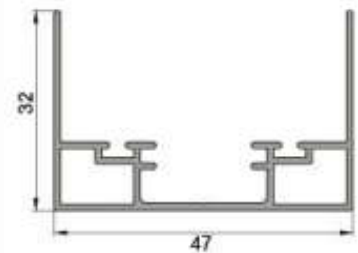

Name: single point single side seal	Length: 4.8m
Thickness: 1.0mm	Weight per meter: 0.479kg/m

Model: YDL-292A

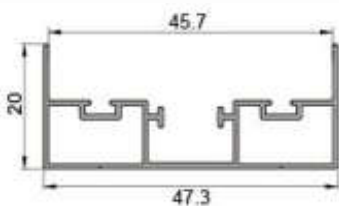

Name: single point single side seal	Length: 4.8m
Thickness: 0.8mm	Weight per meter: 0.35kg/m

Model: YDL-1643

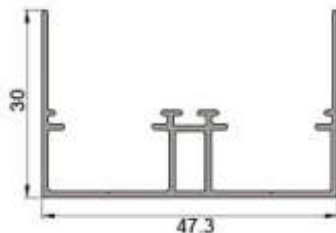

Name: double hook single side seal	Length: 4.8m
Thickness: 1.0mm	Weight per meter: 0.411kg/m

Model: YDL-317

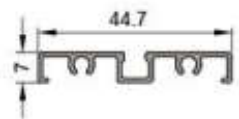

Name: Single lower rail	Length: 6m
Thickness: 1.0mm	Weight per meter: 0.262kg/m

Model: YDL-316

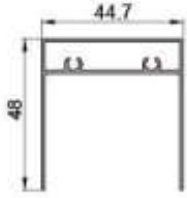

Name: single upper rail	Length: 6m
Thickness: 1.0mm	Weight per meter: 0.54kg/m

Model: YDL-316A

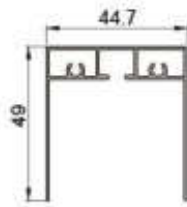

Name: single upper rail	Length: 6m
Thickness: 1.0mm	Weight per meter: 0.583kg/m

Model: YDL-1640

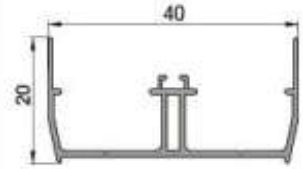

Name: double hook closure	Length: 4.8m
Thickness: 1.0mm	Weight per meter: 0.254kg/m

Model: YDL-299

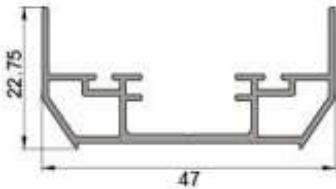

Name: single point closure	Length: 4.8m
Thickness: 1.0mm	Weight per meter: 0.41kg/m

Model: YDL-299A

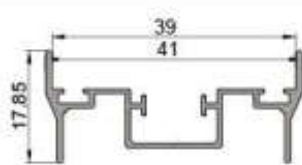

Name: single point closing	Length: 4.8m
Thickness: 1.0mm	Weight per meter: 0.271kg/m

Model: YDL-2218



Name: single closing	Length: 4.8m
Thickness: 2.0mm	Weight per meter: 0.2kg/m

Model: YDL-2223A

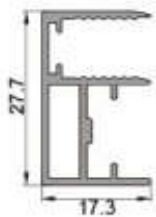

Name: ultra narrow bag	Length: 6.4m
Thickness: 1.2mm	Weight per meter: 0.306kg/m

Model: YDL-4048

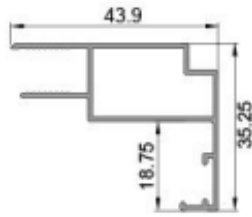

Name: front frame	Length: 6.4m
Thickness: 1.2mm	Weight per meter: 0.395kg/m

Model: YDL-3511

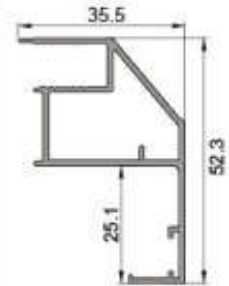

Name: package	Length: 6.4m
Thickness: 1.2mm	Weight per meter: 0.523kg/m

Model: YDL-2229	Thickness: 1.0mm
Name: single buckle strip	Weight per meter: 0.148kg/m
Matching ultra-narrow edge seal	Length: 6m

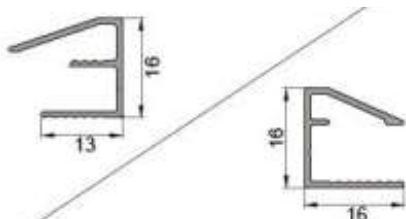

Model: YDL-2230	Thickness: 1.0mm
Name: Fully covered buckle strip	Weight per meter: 0.132kg/m

Model: YDL-4038	Thickness: 1.0mm
Name: single buckle strip	Weight per meter: 0.122kg/m
Matching 20 high side seal	Length: 6m

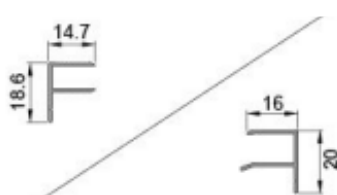

Model: YDL-4039	Thickness: 1.0mm
Name: double pack F slot	Weight per meter: 0.142kg/m

Model: YDL-19082	Thickness: 0.8mm
Name: single pack P slot	Weight per meter: 0.109ka/m
Matching 30 high side seal	Length: 6m

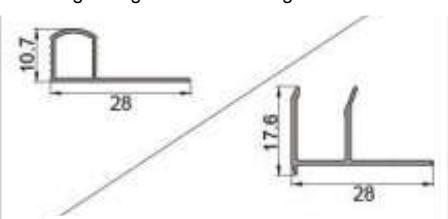

Model: YDL-19079	Thickness: 1.0mm
Name: double pack F slot	Weight per meter: 0.516kg/m





Model: YDL-830

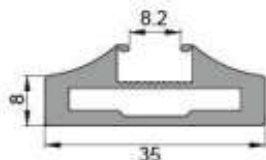

Name: flat section	Length: 6.2m
Thickness: *mm	Weight per meter: 0.55kg/m

Model: YDL-0935

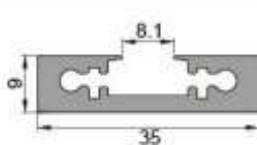

Name: flat section	Length: 6.2m
Thickness: 2.6mm	Weight per meter: 0.517kg/m

Model: YDL-825

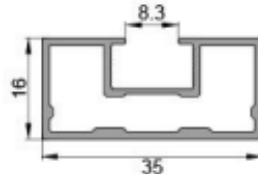

Name: flat section	Length: 6.2m
Thickness: 1.2mm	Weight per meter: 0.388kg/m

Model: YDL-2214

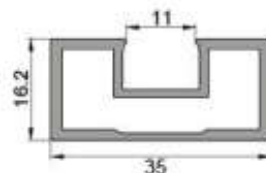

Name: flat section	Length: 6.2m
Thickness: 1.8mm	Weight per meter: 0.48kg/m

Model: YDL-1635

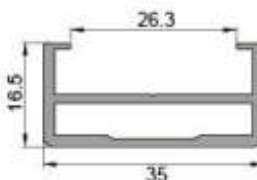

Name: flat section	Length: 6.2m
Thickness: 1.8mm	Weight per meter: 0.423kg/m

Model: YDL-1735

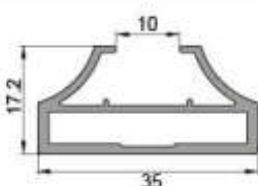

Name: flat section	Length: 6.2m
Thickness: 1.8mm	Weight per meter: 0.408kg/m

Model: YDL-1738

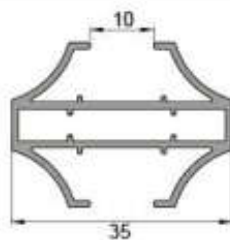

Name: middle horizontal	Length: 6.2m
Thickness: 1.1mm	Weight per meter: 0.447kg/m

Model: YDL-3507

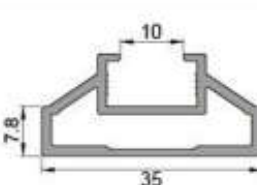

Name: flat section	Length: 6.2m
Thickness: 1.6mm	Weight per meter: 0.392kg/m

Model: YDL-3513

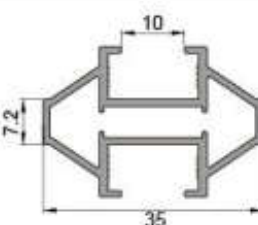

Name: middle horizontal	Length: 6m
Thickness: 1.1mm	Weight per meter: 0.422kg/m

Model: YDL-3514

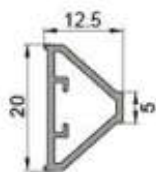

Name: self-adhesive middle horizontal	Length: 6m
Thickness: 1.1mm	Weight per meter: 0.167kg/m

Model: YDL-2223A



Name: front frame	Length: 6.4m
Thickness: 1.2mm	Weight per meter: 0.306kg/m

Model: YDL-2221

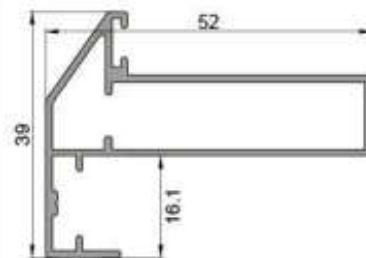

Name: ultra-narrow positive hemming	Length: 6.4m
Thickness: 1.1mm	Weight per meter: 0.557kg/m

Model: YDL-2222

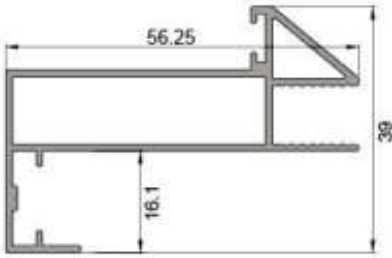

Name: ultra-narrow reverse hemming
Length: 6.4m
Thickness: 1.1mm
Weight per meter: 0.608kg/m

Model: YDL-3510

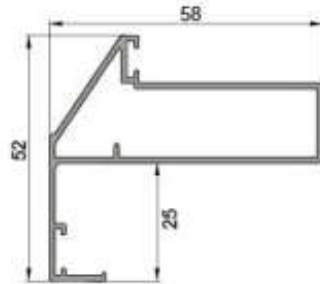

Name: front side cover
Length: 6.4m
Thickness: 1.2mm
Weight per meter: 0.67kg/m

Model: YDL-3512

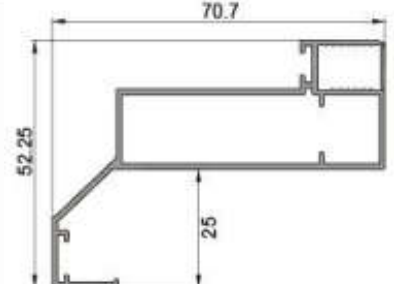

Name: reverse back frame
Length: 6.4m
Thickness: 1.2mm
Weight per meter: 0.758kg/m

Model: YDL-19097

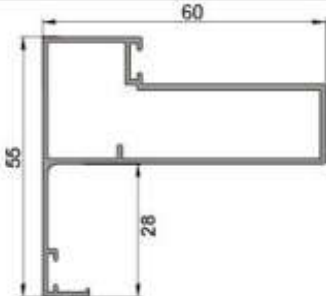

Name: front side cover
Length: 6.4m
Thickness: 1.1mm
Weight per meter: 0.672kg/m

Model: YDL-19096

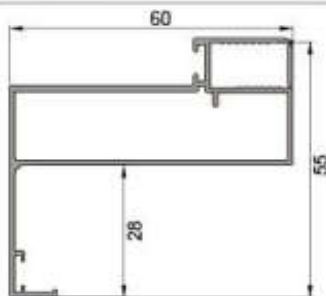

Name: reverse back frame
Length: 6.4m
Thickness: 1.1mm
Weight per meter: 0.715kg/m

Model: YDL-19096F

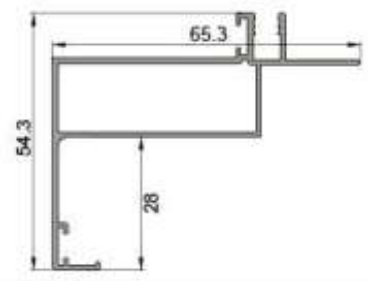

Name: double pack rear frame
Length: 6.4m
Thickness: 1.1mm
Weight per meter: 0.628kg/m

Model: YDL-2249

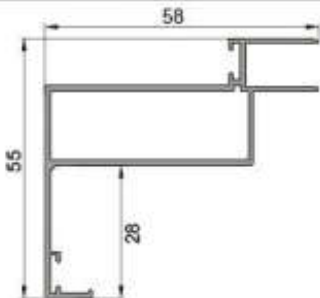

Name: double pack rear frame
Length: 6.4m
Thickness: 1.1mm
Weight per meter: 0.627kg/m

Model: YDL-3511



Name: surround
Length: 6.4m
Thickness: 1.2mm
Weight per meter: 0.523kg/m

Model: YDL-19098

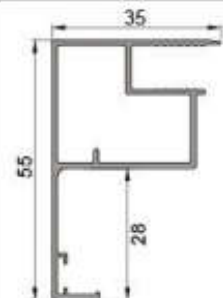

Name: surround
Length: 6.4m
Thickness: 1.1mm
Weight per meter: 0.514kg/m

Model: YDL-2224
Name: reverse buckle strip
Length: 6.4m
Thickness: 1.1mm
Weight per meter: 0.074kg/m

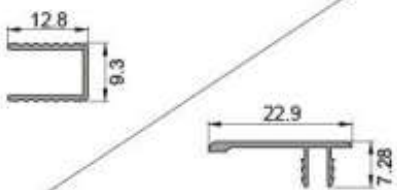

Length: 6.4m

Model: YDL-19080

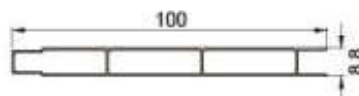

Name: gusset board
Length: 6.3m
Thickness: 0.55mm
Weight per meter: 0.35kg/m

Model: YDL-041
Name: gusset board
Length: 6.3m
Thickness: 0.6mm
Weight per meter: 0.48kg/m

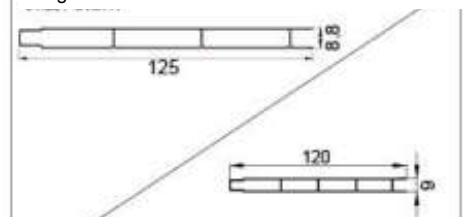

Length: 6.3m

Model: YDL-19081
Name: rear slot F frame
Thickness: 1.0mm
Weight per meter: 0.092kg/m

Model: YDL-8306C
Name: gusset board
Thickness: 0.6mm
Weight per meter: 0.457kg/m



FREEZE-FRAME

the most beautiful side



Model: YDL-813

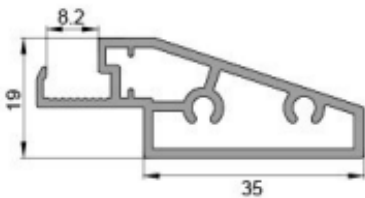

Name: flat section	Length: 6.2m
Thickness: 1.5mm	Weight per meter: 0.609kg/m

Model: YDL-814

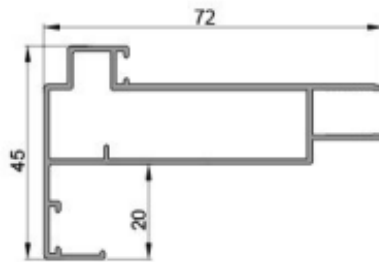

Name: outer frame	Length: 6.4m
Thickness: 1.2mm	Weight per meter: 0.757kg/m

Model: YDL-815

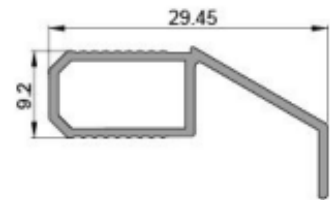

Name: card strip	Length: 6.4m
Thickness: 1.0mm	Weight per meter: 0.172kg/m

Model: YDL-4048

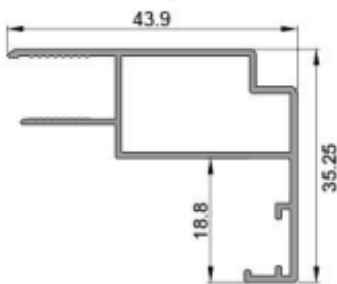

Name: front frame	Length: 6.4m
Thickness: 1.0mm	Weight per meter: 0.395kg/m

Calculation Formula
(for reference only)

35Flat outside and open inside formula:
vertical outer frame = total height + 20

Horizontal frame = total width + 40

Flat section= total height - 30

Top and bottom = total width - 42

Glass: High = Light-20

Width = top and bottom - 20

Minimalist and light luxury

Largevsen·argewith

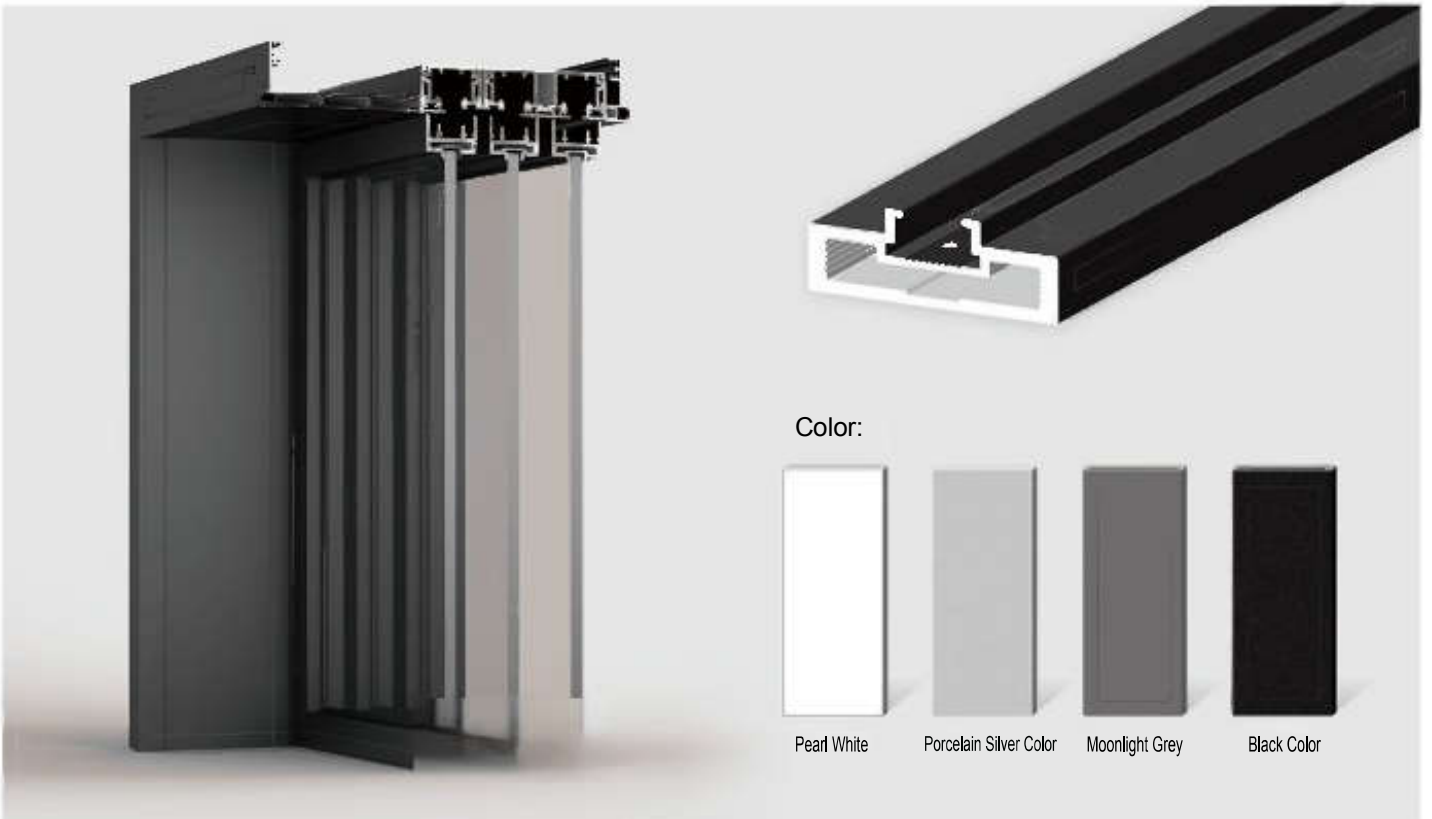

Model: YDL-801

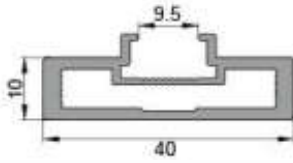

Name: flat section	Length: 4.8m
Thickness: 3.0mm	Weight per meter: 0.525kg/m

Model: YDL-802

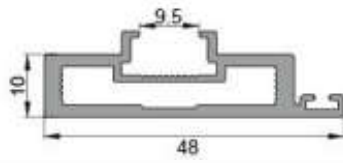

Name: hook section	Length: 4.8m
Thickness: 3.0mm	Weight per meter: 0.571kg/m

Model: YDL-803

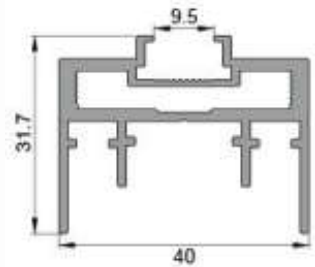

Name: top and bottom	Length: 6m
Thickness: 3.0mm	Weight per meter: 0.772kg/m

Model: YDL-804

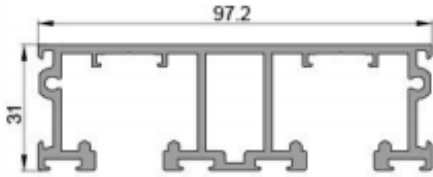

Name: double hanging track	Length: 6m
Thickness: 2.0mm	Weight per meter: 1.84kg/m

Model: YDL-805

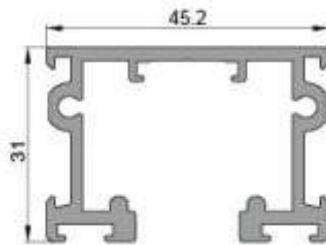

Name: single hanging wire	Length: 6m
Thickness: 2.0mm	Weight per meter: 0.917kg/m

Model: YDL-806G

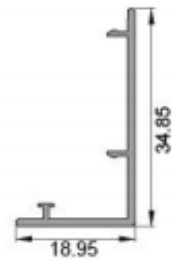

Name: hanging rail side cover	Length: 6m
Thickness: 1.2mm	Weight per meter: 0.193kg/m

Model: YDL-807

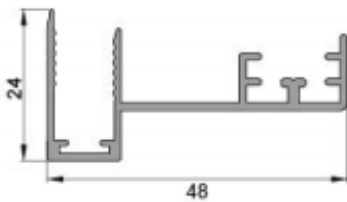

Name: edge line	Length: 6.4m
Thickness: 1.2mm	Weight per meter: 0.398kg/m

Model: YDL-808

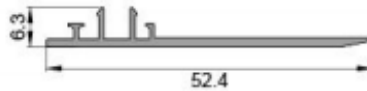

Name: line rail closing strip	Length: 6m
Thickness: 1.5mm	Weight per meter: 0.233kg/m

Model: YDL-810

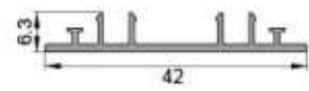

Name: hanging rail decorative cover	Length: 6m
Thickness: 1.3mm	Weight per meter: 0.208kg/m

Model: YDL-811

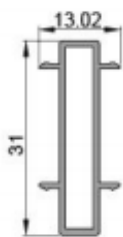

Name: hanging rail connector	Length: 6m
Thickness: 1.0mm	Weight per meter: 0.222kg/m

Panoramic view

Experience and comfort, narrow frame appearance of high-end fashion, super wide field of vision to make the visual effect is excellent

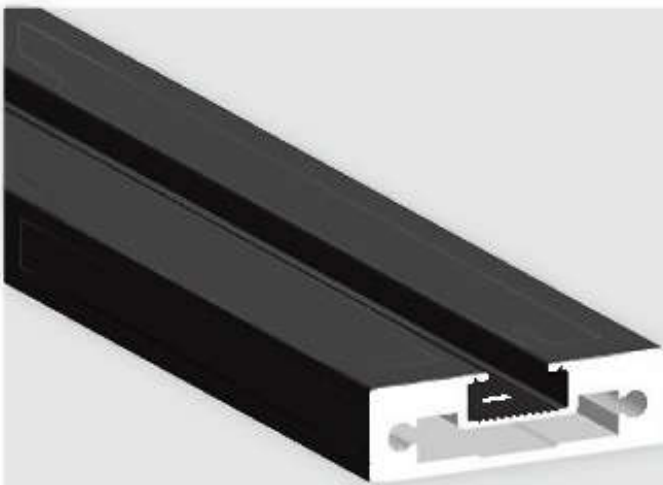

Color:



Pearl White



Black Color



Silver Grey



Phantom Gray



Model: YDL-833

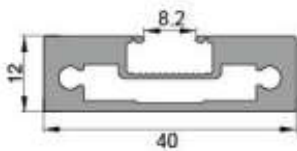

Name: flat section	Length: 4.8m
Thickness: *mm	Weight per meter: 0.7kg/m

Model: YDL-834

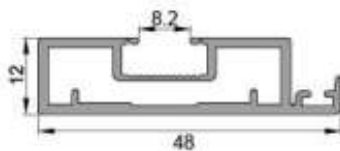

Name: hook section	Length: 4.8m
Thickness: 1.5mm	Weight per meter: 0.502kg/m

Model: YDL-835

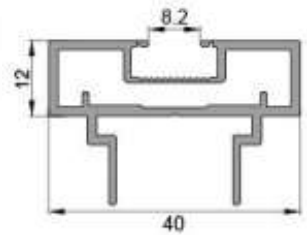

Name: top and bottom	Length: 6m
Thickness: 1.5mm	Weight per meter: 0.57kg/m

Model: XL-ZN1

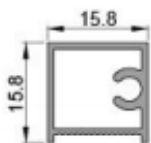

Name: self-adhesive strips	Length: 6m
Thickness: 1.0mm	Weight per meter: 0.192kg/m

Model: XL-ZN2

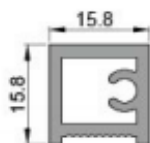

Name: self-adhesive strips	Length: 6m
Thickness: 2.0mm	Weight per meter: 0.331kg/m

Booking

Calculation Formula
(for reference only)

4012 Two-track two sash: side seal = total height

Upper and lower rails = total width - 40

Flat section = total height - 80

Top and bottom = total width - 20 ÷ 2

Glass: High = flat section - 15

Width = top and bottom - 15

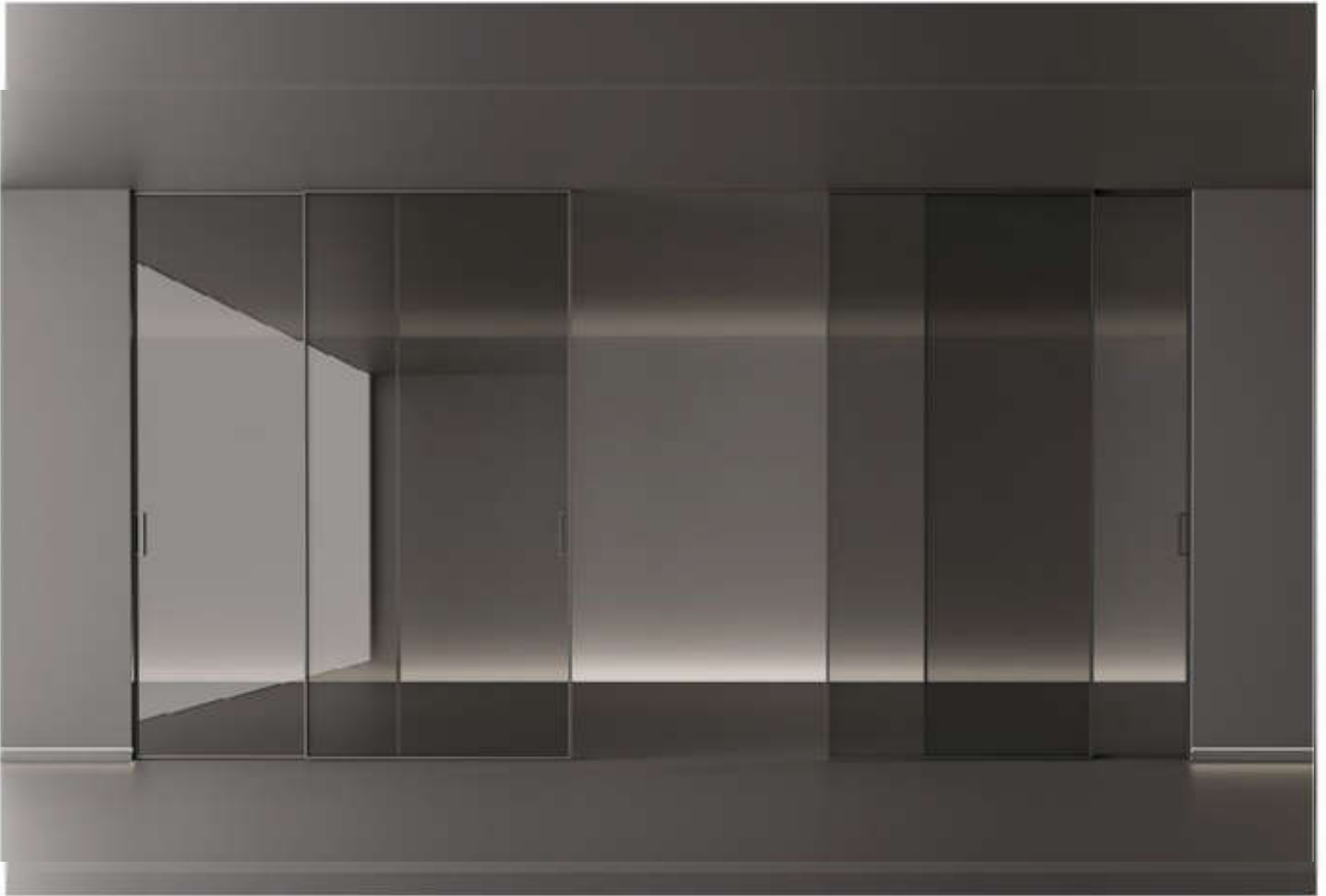

Minimalist style, beautiful narrow frame

Ultra-narrow border

More beautiful

Better light transmittance



Model: YDL-801

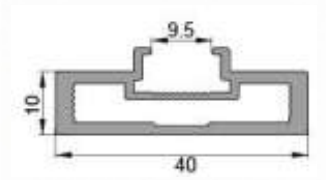

Name: flat section	Length: 4.8m
Thickness: 3.0mm	Weight per meter: 0.525kg/m

Model: YDL-802

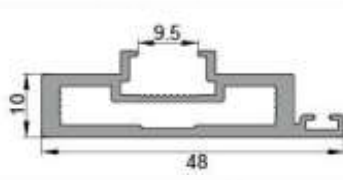

Name: hook section	Length: 4.8m
Thickness: 3.0mm	Weight per meter: 0.571kg/m

Model: YDL-803B

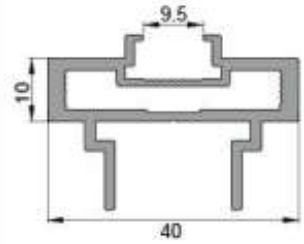

Name: top and bottom	Length: 6m
Thickness: 3.0mm	Weight per meter: 0.68kg/m

Model: YDL-822

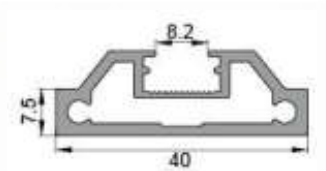

Name: flat section	Length: 4.8m
Thickness: 2.0mm	Weight per meter: 0.52kg/m

Model: YDL-822H

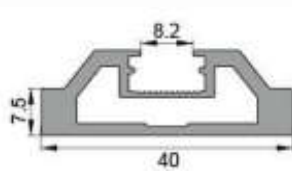

Name: flat section	Length: 4.8m
Thickness: 2.0mm	Weight per meter: 0.61kg/m

Model: YDL-823

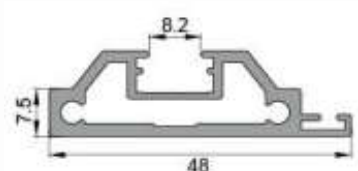

Name: hook section	Length: 4.8m
Thickness: 2.0mm	Weight per meter: 0.56kg/m

Model: YDL-824

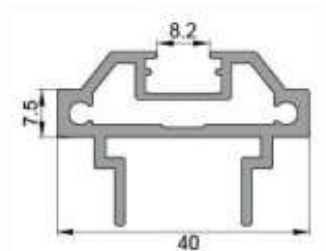

Name: top and bottom	Length: 6m
Thickness: 2.0mm	Weight per meter: 0.676kg/m

Model: YDL-4005

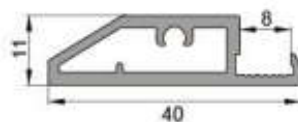

Name: flat section	Length: 4.8m
Thickness: 2.0mm	Weight per meter: 0.46kg/m

Model: YDL-4006

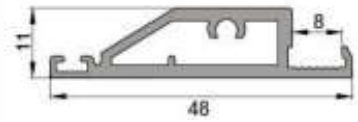

Name: left hook section	Length: 4.8m
Thickness: 2.0mm	Weight per meter: 0.505kg/m

Model: YDL-4007

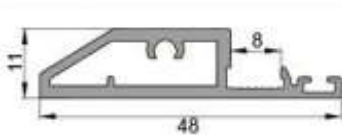

Name: right hook section	Length: 4.8m
Thickness: 2.0mm	Weight per meter: 0.506kg/m

Model: YDL-4008

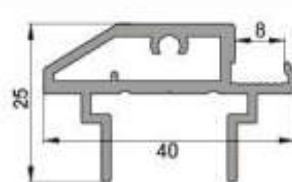

Name: top and bottom	Length: 6m
Thickness: 2.0mm	Weight per meter: 0.571kg/m

Color:



Angel White



Porcelain Silver Color



Moonlight Grey



Black Color

Model: YDL-4025

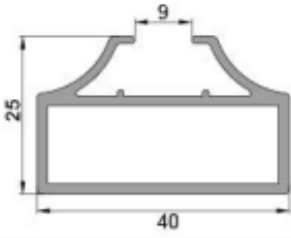

Name: flat section	Length: 4.8m
Thickness: 1.8mm	Weight per meter: 0.599kg/m

Model: YDL-4026

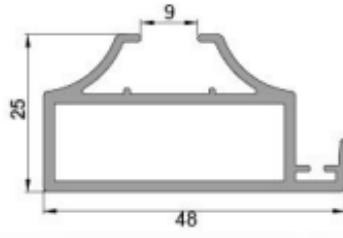

Name: hook section	Length: 4.8m
Thickness: 1.8mm	Weight per meter: 0.668kg/m

Model: YDL-4027

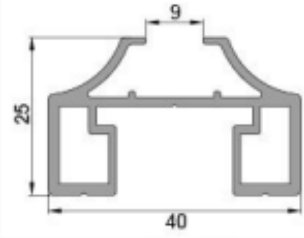

Name: top and bottom	Length: 6m
Thickness: 1.8mm	Weight per meter: 0.612kg/m

Model: YDL-4028

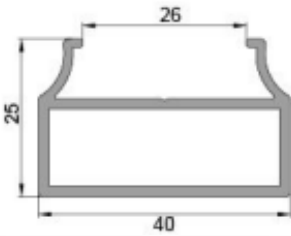

Name: flat section	Length: 4.8m
Thickness: 1.8mm	Weight per meter: 0.556kg/m

Model: YDL-4029

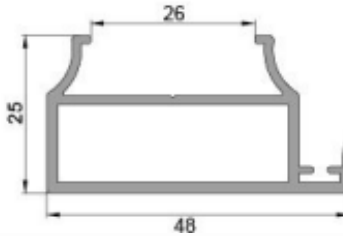

Name: hook section	Length: 4.8m
Thickness: 1.8mm	Weight per meter: 0.625kg/m

Model: YDL-4030

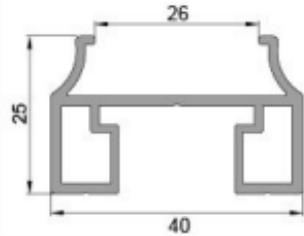

Name: top and bottom	Length: 6m
Thickness: 1.8mm	Weight per meter: 0.574kg/m

Model: YDL-4009

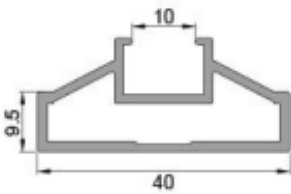

Name: flat section	Length: 4.8m
Thickness: 1.6mm	Weight per meter: 0.462kg/m

Model: YDL-4010

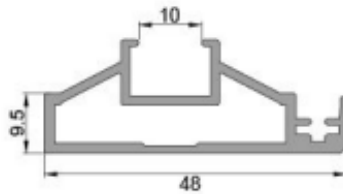

Name: hook section	Length: 4.8m
Thickness: 1.6mm	Weight per meter: 0.548kg/m

Model: YDL-4011

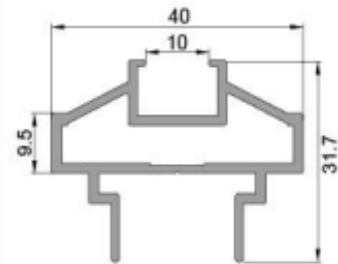

Name: top and bottom	Length: 6m
Thickness: 1.6mm	Weight per meter: 0.591kg/m

Model: YDL-0940

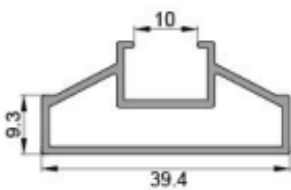

Name: flat section	Length: 4.8m
Thickness: 1.2mm	Weight per meter: 0.379kg/m

订货

Model: YDL-0941

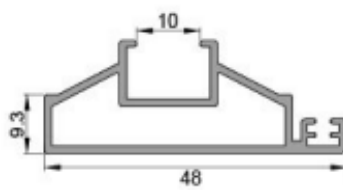

Name: hook section	Length: 4.8m
Thickness: 1.2mm	Weight per meter: 0.446kg/m

订货

Model: YDL-0942

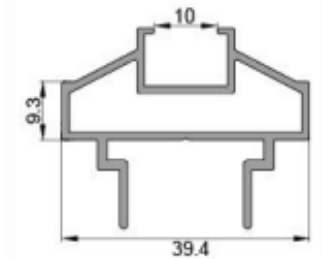

Name: top and bottom	Length: 6m
Thickness: 1.2mm	Weight per meter: 0.507kg/m

订货

Model: YDL-4012

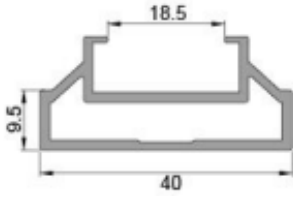

Name: flat section	Length: 4.8m
Thickness: 1.6mm	Weight per meter: 0.474kg/m

Model: YDL-4013

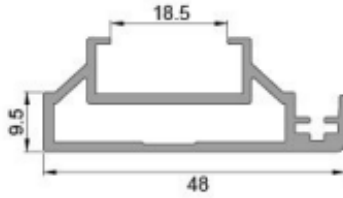

Name: hook section	Length: 4.8m
Thickness: 1.6mm	Weight per meter: 0.559kg/m

Model: YDL-4014

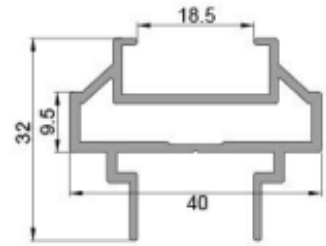

Name: top and bottom	Length: 6m
Thickness: 1.6mm	Weight per meter: 0.602kg/m

Model: YDL-4015

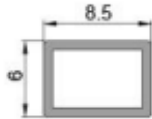

Name: grid strips	Length: 6m
Thickness: 0.7mm	Weight per meter: 0.05kg/m

PANORANIC FIELD OF VIEW

Experience and enjoy comfort, narrow frame appearance high-end fashion, ultra-wide field of view for excellent visual effects



Model: YDL-4031

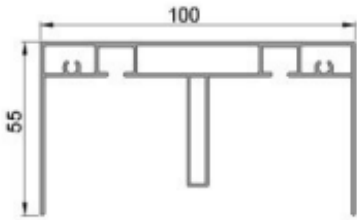

Name: double

upper rail Length: 6m

Thickness: 1.3mm Weight per meter:
1.219kg/m

Model: YDL-4032

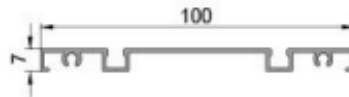

Name: double

lower rail Length: 6m

Thickness: 1.0mm Weight per meter:
0.462kg/m

Model: YDL-4033

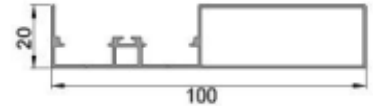

Name: double

side cover Length: 4.8m

Thickness: 1.0mm Weight per meter:
0.705kg/m

Model: YDL-4034

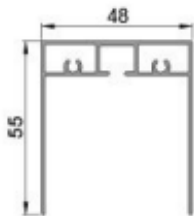

Name: single

upper rail Length: 6m

Thickness: 1.0mm Weight per meter:
0.669kg/m

Model: YDL-4035

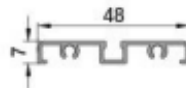

Name: single

lower rail Length: 6m

Thickness: 1.0mm Weight per meter:
0.276kg/m

Model: YDL-4036

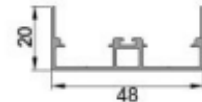

Name: single

side cover Length: 4.8m

Thickness: 1.0mm Weight per meter:
0.349kg/m

Model: YDL-4037



Name: closed ends Length: 4.8m

Thickness: 1.0mm Weight per meter:
0.304kg/m

Model: YDL-4038

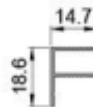

Name: single bag

buckle Length: 6m

Thickness: 1.0mm Weight per meter:
0.122kg/m

Model: YDL-4039

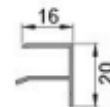

Name: double package

F slot Length: 6m

Thickness: 1.0mm Weight per meter:
0.142kg/m

Model: YDL-290

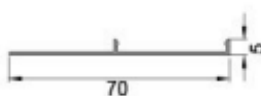

Name: hanger cover Length: 6m

Thickness: 1.0mm Weight per meter:
0.203kg/m

Model: YDL-4040

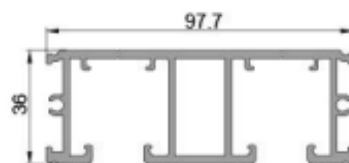

Name: double rail Length: 6m

Thickness: 2.0mm Weight per meter:
2.03kg/m

Model: YDL-4041

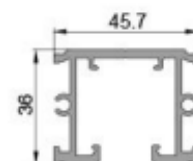

Name: single rail Length: 6m

Thickness: 2.0mm Weight per meter:
1.02kg/m

Model: YDL-4042



Name: rail connector	Length: 6m
Thickness: 1.2mm	Weight per meter: 0.263kg/m

Model: YDL-4043



Name: three side seal	Length: 4.8m
Thickness: 1.3mm	Weight per meter: 1.26kg/m

Model:YDL-4044

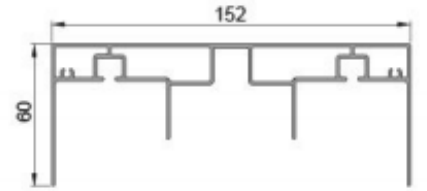

Name:three upper track	Length:6m
Thickness:1.3mm	Weight per meter: 1.982kg/m

Model:4045



Name:three lower track	Length:6m
Thickness:1.3mm	Weight per meter:0.8kg/m

Model: YDL-4050

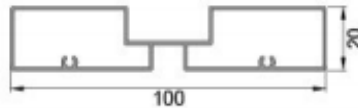

Name: bright window	Length: 6m
Thickness: 1.0mm	Weight per meter: 0.688kg/m

Model: YDL-4048

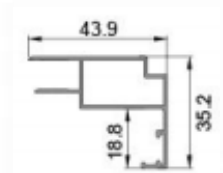

Name: front frame	Length: 6m
Thickness: 1.2mm	Weight per meter: 0.395kg/m

Model: YDL-19080

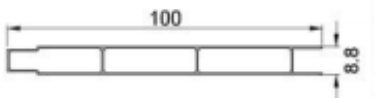

Name: buckle	Length: 6.3m
Thickness: 0.55mm	Weight per meter: 0.35kg/m

Model:8306C

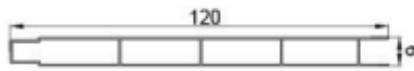

Name:gusset board	Length:6.3m
Thickness:0.6mm	Weight per meter:0.457kg/m

Model: YDL-041

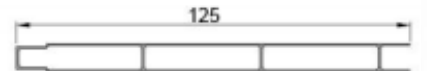

Name: buckle	Length: 6.3m
Thickness: 0.6mm	Weight per meter: 0.48kg/m

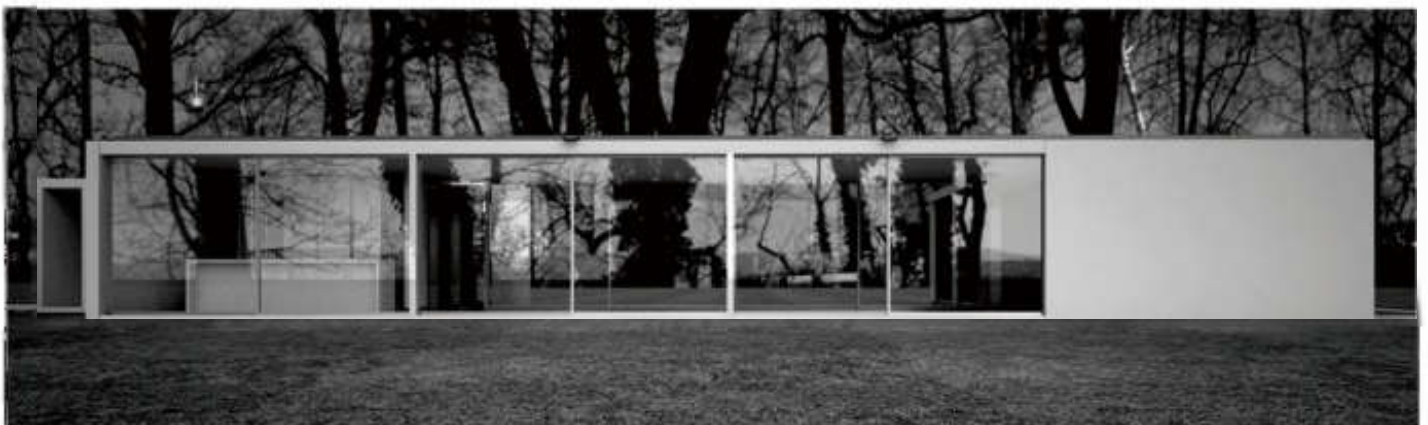



Model: YDL-833

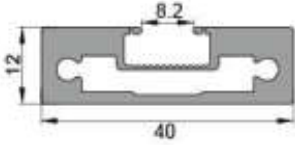

Name: flat section	Length: 6.2m
Thickness: *mm	Weight per meter: 0.691kg/m

Model: YDL-4005

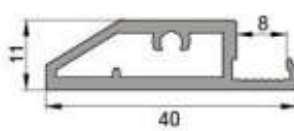

Name: flat section	Length: 6.2m
Thickness: 2.0mm	Weight per meter: 0.46kg/m

Model: YDL-4009

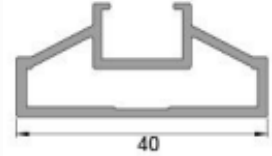

Name: flat section	Length: 6.2m
Thickness: 1.6mm	Weight per meter: 0.462kg/m

Model: YDL-4015

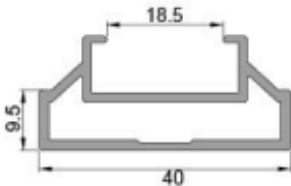

Name: flat section	Length: 6.2m
Thickness: 1.6mm	Weight per meter: 0.474kg/m

Model: YDL-4025

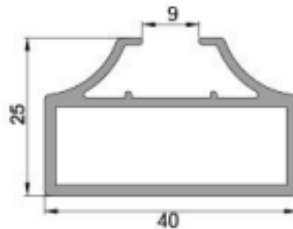

Name: flat section	Length: 6.2m
Thickness: 1.8mm	Weight per meter: 0.599kg/m

Model: YDL-4028

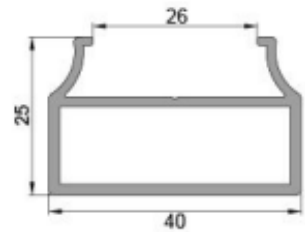

Name: flat section	Length: 6.2m
Thickness: 1.8mm	Weight per meter: 0.556kg/m

Model: YDL-4046

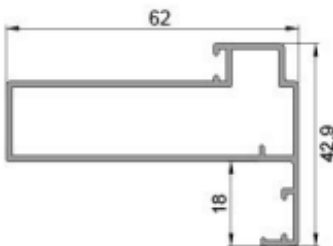

Name: front wrap	Length: 6.4m
Thickness: 1.2mm	Weight per meter: 0.665kg/m

Model: YDL-4047

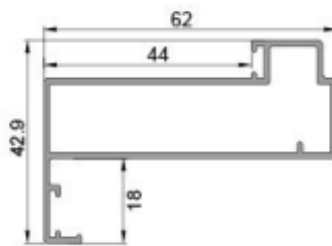

Name: reverse wrap	Length: 6.4m
Thickness: 1.2mm	Weight per meter: 0.665kg/m

Model: YDL-4048



Name: front frame	Length: 6.4m
Thickness: 1.2mm	Weight per meter: 0.395kg/m

Model: YDL-4049

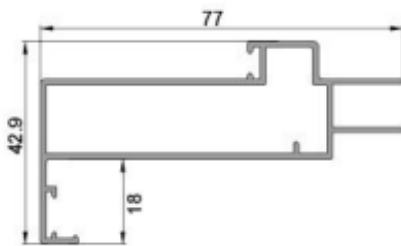

Name: double pack back frame	Length: 6.4m
Thickness: 1.2mm	Weight per meter: 0.749kg/m

Model: YDL-19082

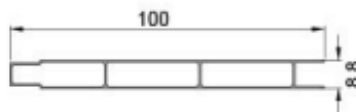

Name: buckle	Length: 6.3m
Thickness: 0.55mm	Weight per meter: 0.35kg/m

Model: YDL-041	Thickness: 0.6mm
Name: gusset board	Weight per meter: 0.48kg/m

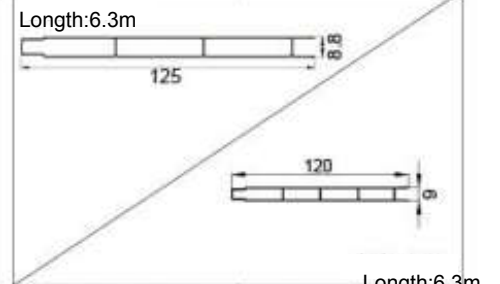

Model: YDL-8306C	Thickness: 0.6mm
Name: gusset board	Weight per meter: 0.457kg/m



Color:



Angel White

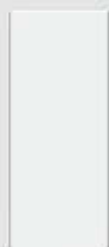

Pearl White



Porcelain grey



New Oxygen Ceramic Gray



Moonlight Grey



New Oxygen Gray



Black Color

Model: YDL-1645

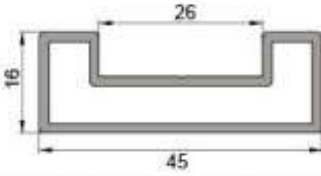

Name: flat section	Length: 4.8m
Thickness: 1.6mm	Weight per meter: 0.53kg/m

Model: YDL-1646

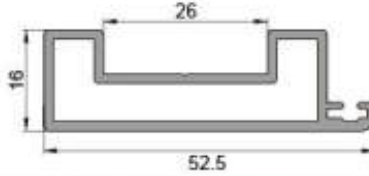

Name: hook section	Length: 4.8m
Thickness: 1.6mm	Weight per meter: 0.584kg/m

Model: YDL-1647

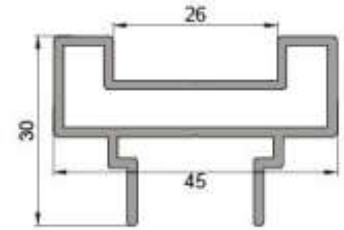

Name: top and bottom	Length: 6m
Thickness: 1.6mm	Weight per meter: 0.676kg/m

Model: YDL-2246

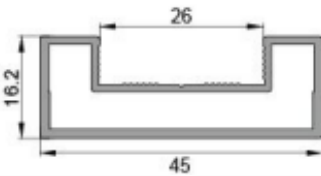

Name: flat section	Length: 4.8m
Thickness: 1.4mm	Weight per meter: 0.471kg/m

Model: YDL-2247

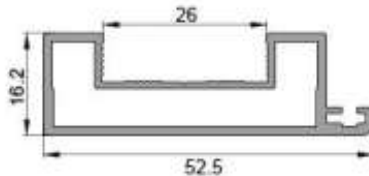

Name: hook section	Length: 4.8m
Thickness: 1.4mm	Weight per meter: 0.524kg/m

Model: YDL-2248

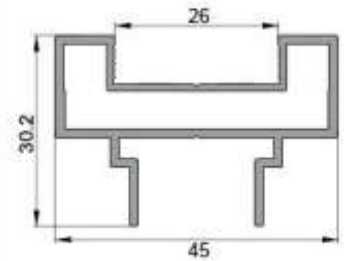

Name: top and bottom	Length: 6m
Thickness: 1.4mm	Weight per meter: 0.599kg/m

Model: YDL-4516

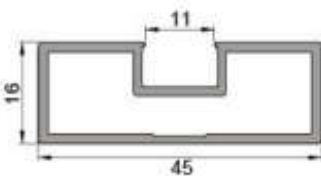

Name: flat section	Length: 4.8m
Thickness: 1.6mm	Weight per meter: 0.529kg/m

Model: YDL-4517

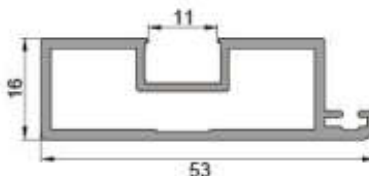

Name: hook section	Length: 4.8m
Thickness: 1.6mm	Weight per meter: 0.586kg/m

Model: YDL-4515

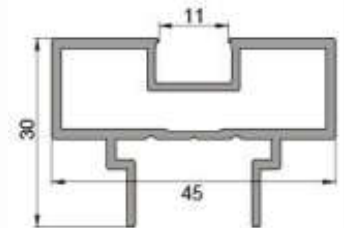

Name: top and bottom	Length: 6m
Thickness: 1.6mm	Weight per meter: 0.653kg/m

Model: YDL-2205

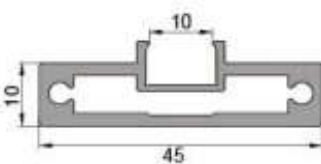

Name: flat section	Length: 4.8m
Thickness: 2.0mm	Weight per meter: 0.615kg/m

Model: YDL-2206

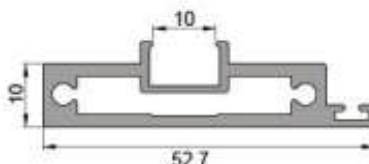

Name: hook section	Length: 4.8m
Thickness: 2.0mm	Weight per meter: 0.66kg/m

Model: YDL-2207

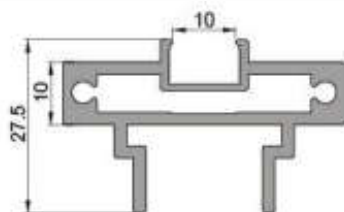

Name: top and bottom	Length: 6m
Thickness: 2.0mm	Weight per meter: 0.798kg/m

Model: YDL-2234

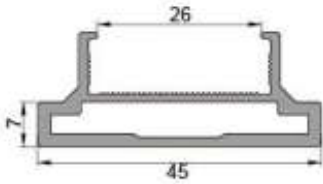

Name: flat section	Length: 4.8m
Thickness: 2.0mm	Weight per meter: 0.54kg/m

Model: YDL-2235

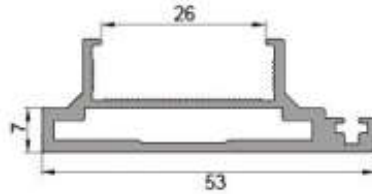

Name: hook section	Length: 4.8m
Thickness: 2.0mm	Weight per meter: 0.612kg/m

Model: YDL-2236

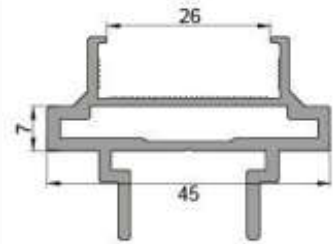

Name: top and bottom	Length: 6m
Thickness: 2.0mm	Weight per meter: 0.726kg/m

Model: YDL-2211

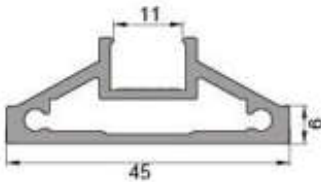

Name: flat section	Length: 4.8m
Thickness: 2.0mm	Weight per meter: 0.596kg/m

Model: YDL-2212

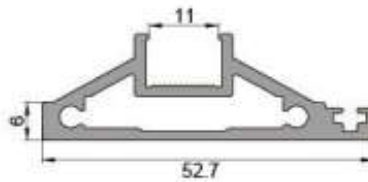

Name: hook section	Length: 4.8m
Thickness: 2.0mm	Weight per meter: 0.668kg/m

Model: YDL-2231

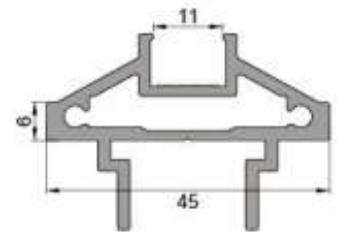

Name: top and bottom	Length: 6m
Thickness: 2.0mm	Weight per meter: 0.782kg/m

Model: YDL-4518

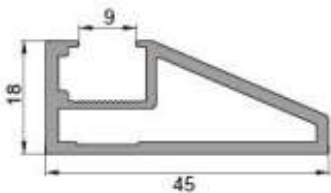

Name: flat section	Length: 4.8m
Thickness: 1.8mm	Weight per meter: 0.615kg/m

Model: YDL-4519

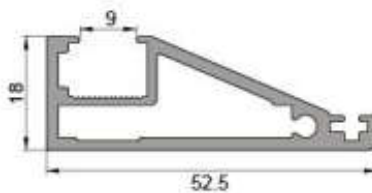

Name: right hook section	Length: 4.8m
Thickness: 1.8mm	Weight per meter: 0.682kg/m

Model: YDL-4520

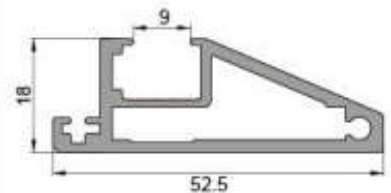

Name: left hook section	Length: 4.8m
Thickness: 2.0mm	Weight per meter: 0.682kg/m

Model: YDL-4521

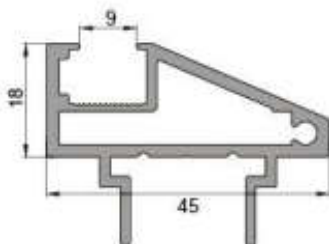

Name: top and bottom	Length: 6m
Thickness: 1.8mm	Weight per meter: 0.769kg/m

CUSTOMIZES

Windows make the space brighter and give it life and soul

Model: YDL-207

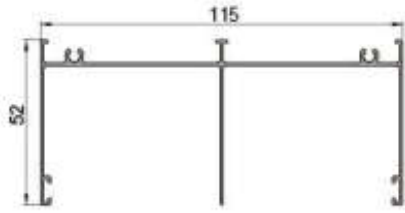

Name: upper track	Length: 6m
Thickness: 1.0mm	Weight per meter: 0.892kg/m

Model: YDL-208

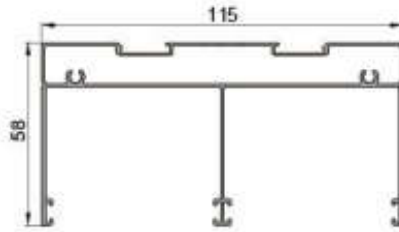

Name: upper track	Length: 6m
Thickness: 1.0mm	Weight per meter: 1.25kg/m

Model: YDL-208A

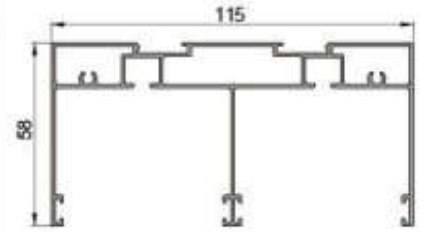

Name: upper track	Length: 6m
Thickness: 1.2mm	Weight per meter: 1.445kg/m

Model:JZ-209



Name: lower track	Length:6m
Thickness:1.0mm	Weight per meter:0.542kg/m

Model:JZ-210

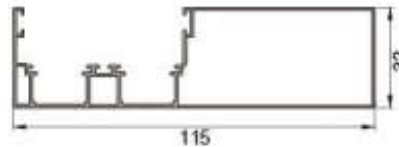

Name: double side seal	Length:4.8m
Thickness: 1.0mm	Weight per meter: 0.909kg/m

Model:YDL-2209

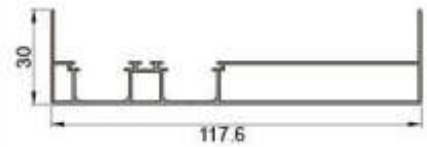

Name:flush double side seal	Length:4.8m
Thickness:0.9mm	Weight per meter:0.799kg/m

Model:YDL-2227

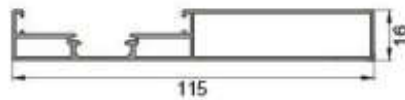

Name:ultra narrow single side seal	Length:4.8m
Thickness:1.1mm	Weight per meter:0.842kg/m

Model: YDL-215

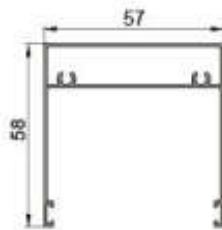

Name: single upper track	Length: 6m
Thickness: 1.0mm	Weight per meter: 0.654kg/m

Model: YDL-217

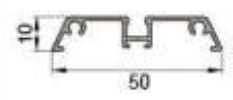

Name: single upper track	Length: 6m
Thickness: 1.1mm	Weight per meter: 0.31kg/m

Model: YDL-216

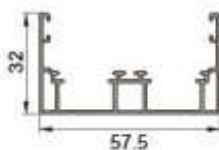

Name: single upper track	Length: 4.8m
Thickness: 1.1mm	Weight per meter: 0.61kg/m

Model: YDL-220

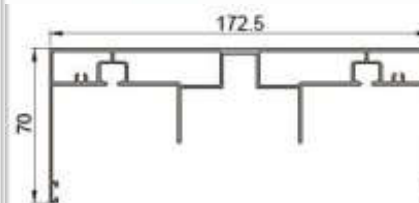

Name: three link upper track	Length: 6m
Thickness: 1.4mm	Weight per meter: 2.335kg/m

Model: YDL-223

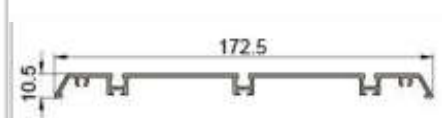

Name: three link lower track	Length: 6m
Thickness: 1.4mm	Weight per meter: 0.997kg/m

Model: JZ-221

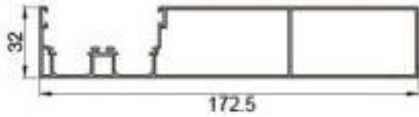

Name: three-link side seal	Length: 4.8m
Thickness: 1.3mm	Weight per meter: 1.657kg/m

Model: YDL-2237

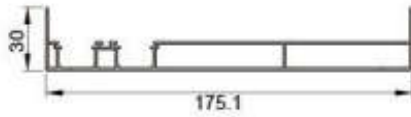

Name: flush three-side seal	Length: 4.8m
Thickness: 1.2mm	Weight per meter: 1.35kg/m

Model: YDL-2228

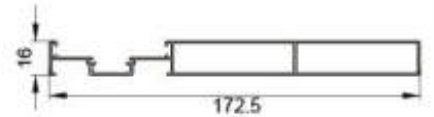

Name: ultra narrow three side seal	Length: 4.8m
Thickness: 1.3mm	Weight per meter: 1.317kg/m

Model: YDL-2231

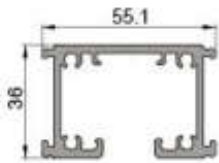

Name: hanging track	Length: 6m
Thickness: 2.0mm	Weight per meter: 1.22kg/m

Model: YDL-2232

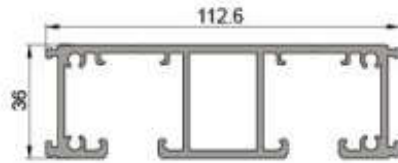

Name: double hanging rail	Length: 6m
Thickness: 2.0mm	Weight per meter: 2.3kg/m

Model: YDL-2233



Name: hanging rail plug-in	Length: 6m
Thickness: 2.0mm	Weight per meter: 0.202kg/m

Model: YDL-290

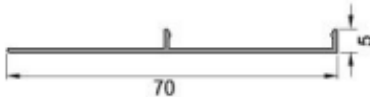

Matching concave wheel hanging rail

Name: hanging rail cover	Length: 6m
Thickness: 1.0mm	Weight per meter: 0.203kg/m

Model: JZ-212

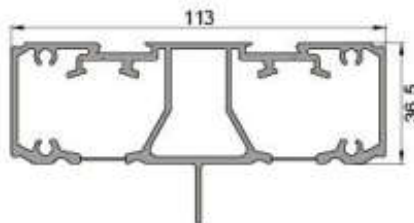

Name: double hanging rails (inclined wheels)	Length: 6m
Thickness: 2.0mm	Weight per meter: 1.52kg/m

Model: JZ-225

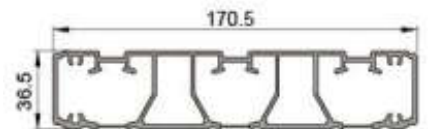

Name: three hanging rails (inclined wheels)	Length: 6m
Thickness: 2.0mm	Weight per meter: 3.31kg/m

Model: JZ-219

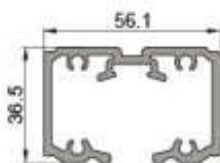

Name: single hanging rails (inclined wheels)	Length: 6m
Thickness: 2.0mm	Weight per meter: 1.367kg/m

Model: JZ-213

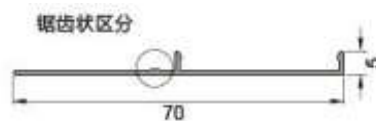

Matching inclined wheel hanging rail

Name: hanging rail cover	Length: 6m
Thickness: 1.0mm	Weight per meter: 0.198kg/m

Model: YDL-2217



Name: sealing port	Length: 4.8m
Thickness: 2.0mm	Weight per meter: 0.266kg/m

Ma
tch
ing

co
nc
ave
e
wh
eel

ha
ngi
ng
rail

Model: JZ-218

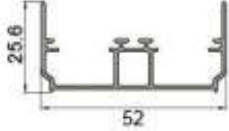

Name: sealing port	Length: 4.8m
Thickness: 1.1mm	Weight per meter: 0.45kg/m

Model: YDL-19098

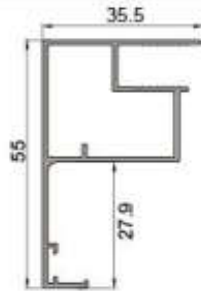

Name:wrapping hemming	Length: 6.4m
Thickness: 1.1mm	Weight per meter: 0.514kg/m

Model: YDL-3511

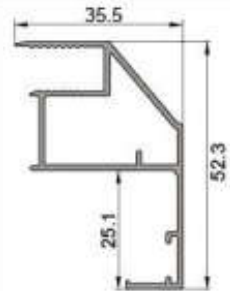

Name:wrapping hemming	Length: 6.4m
Thickness: 1.2mm	Weight per meter: 0.523kg/m

Model: YDL-2110



Name: off the wall wrapping hemming	Length: 6.4m
Thickness: 1.0mm	Weight per meter: 0.28kg/m

Model: YDL-19079

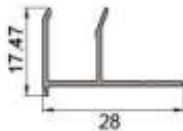

Name:double pack F slot	Length: 6m
Thickness: 1.0mm	Weight per meter: 0.156kg/m

Model: YDL-19082

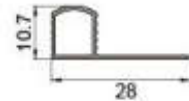

Name:single pack P slot	Length: 6m
Thickness: 0.8mm	Weight per meter: 0.109kg/m

Model:YDL-041 Thickness:0.6mm
Name:gusset board Weight per meter:0.48kg/m

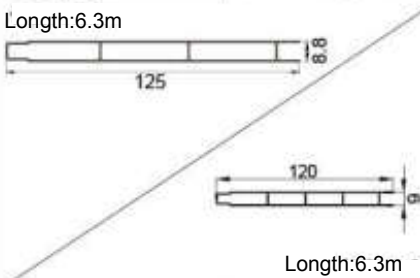

Model:YDL-8306C Thickness:0.6mm
Name: gusset board Weight per meter:0.457kg/m

Model:YDL-19080

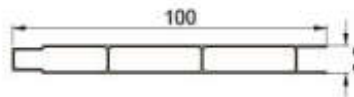

Name:gusset board Length:6.3m
Thickness:0.55mm Weight per meter:0.35kg/m

Model: YDL-8214

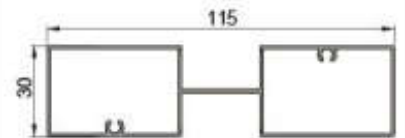

Name:bright window Length: 6m
Thickness: 1.0mm Weight per meter: 0.928kg/m

Model: YDL-2223A

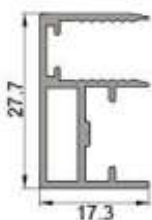

Matching ultra-narrow edge seal

Name:wrapping hemming	Length: 6.4m
Thickness: 1.2mm	Weight per meter: 0.306kg/m

Model: YDL-2230

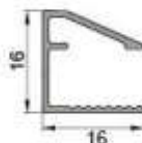

Matching ultra-narrow edge seal

Name:all-inclusive buckle strips	Length: 6m
Thickness: 1.0mm	Weight per meter: 0.132kg/m

Model: YDL-2229



Matching ultra-narrow edge seal

Name:single buckle strip	Length: 6m
Thickness: 1.0mm	Weight per meter: 0.148kg/m



EXTREMELY

Ultra-narrow frame

More beautiful

Better light transmission

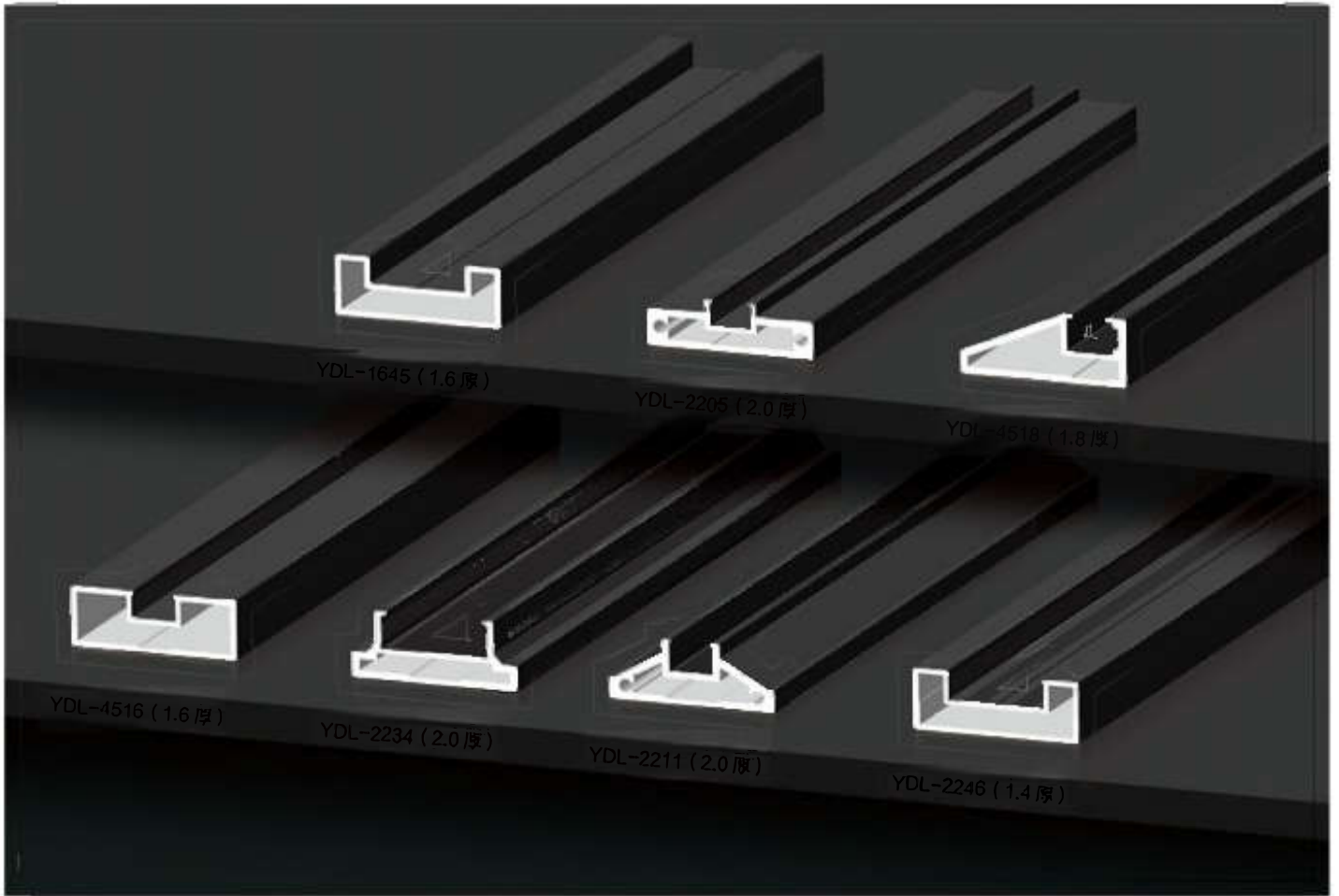

Model: YDL-1645

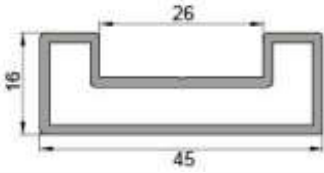

Name:flat section	Length: 6.2m
Thickness: 1.6mm	Weight per meter: 0.53kg/m

Model: YDL-2246

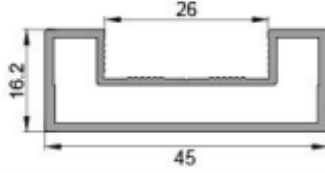

Name:flat section	Length: 6.2m
Thickness: 1.4mm	Weight per meter: 0.471kg/m

Model: YDL-4518

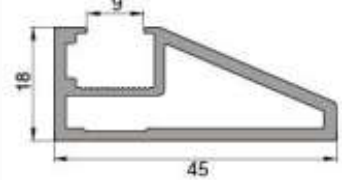

Name:flat section	Length: 6.2m
Thickness: 1.8mm	Weight per meter: 0.615kg/m

Model: YDL-4516

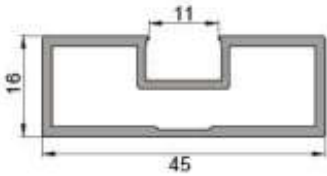

Name:flat section	Length: 6.2m
Thickness: 1.6mm	Weight per meter: 0.529kg/m

Model: YDL-2234

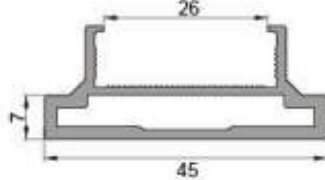

Name:flat section	Length: 6.2m
Thickness: 2.0mm	Weight per meter: 0.54kg/m

Model: YDL-2211

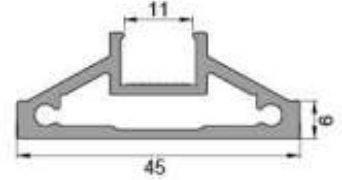

Name:flat section	Length: 6.2m
Thickness: 2.0mm	Weight per meter: 0.596kg/m

Model: YDL-2205

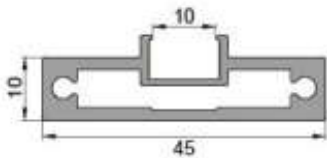

Name:flat section	Length: 6.2m
Thickness: 2.0mm	Weight per meter: 0.615kg/m

Model: YDL-2219

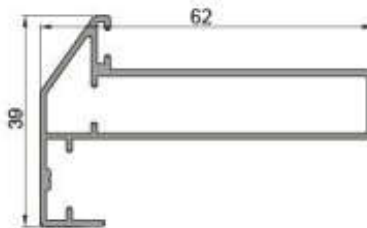

Name:ultra narrow front wrap	Length: 6.4m
Thickness: 1.1mm	Weight per meter: 0.619kg/m

Model: YDL-2220

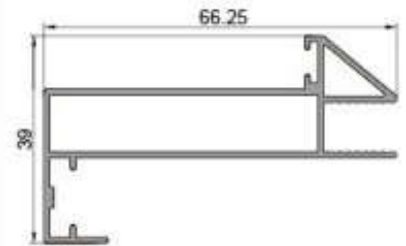

Name:ultra narrow reverse package	Length: 6.4m
Thickness: 1.1mm	Weight per meter: 0.67kg/m

Model: YDL-2223A

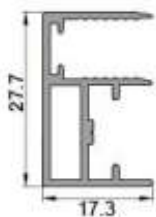

Name:ultra-narrow wrapping edge	Length: 6.4m
Thickness: 1.2mm	Weight per meter: 0.28kg/m

Model: YDL-2224

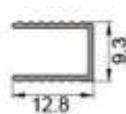

Name:reverse edge wrap buckle strip	Length: 6.4m
Thickness: 1.0mm	Weight per meter: 0.074kg/m

Model: YDL-21101

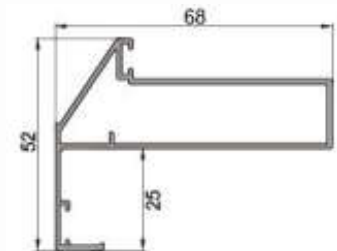

Name:front wrapping	Length: 6.4m
Thickness: 1.2mm	Weight per meter: 0.738kg/m

Model: YDL-21102

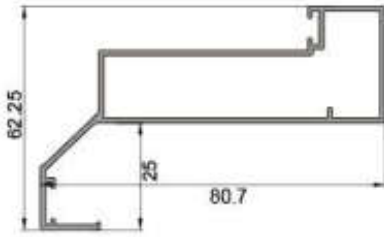

Name:reverse package	Length: 6.4m
Thickness: 1.2mm	Weight per meter: 0.794kg/m

Model: YDL-21103

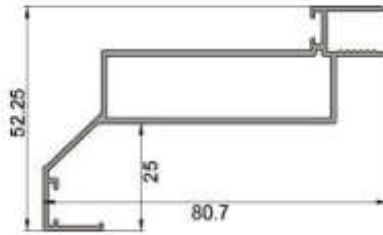

Name:double pack rear frame	Length: 6.4m
Thickness: 1.2mm	Weight per meter: 0.752kg/m

Model: YDL-3511

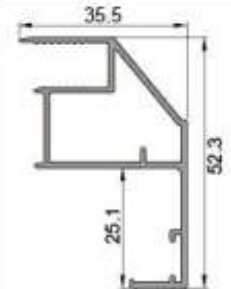

Name:wrapping hemming	Length: 6.4m
Thickness: 1.2mm	Weight per meter: 0.523kg/m

Model: YDL-1648

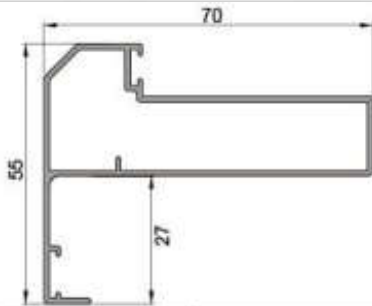

Name: front wrap	Length: 6.4m
Thickness: 1.2mm	Weight per meter: 0.772kg/m

Model: YDL-1649

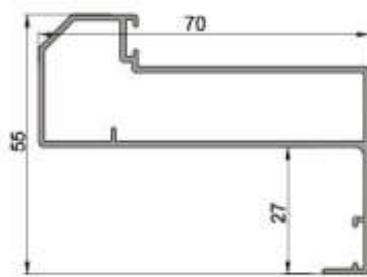

Name: reverse package	Length: 6.4m
Thickness: 1.2mm	Weight per meter: 0.772kg/m

Model: YDL-1650

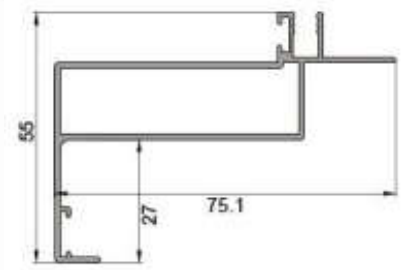

Name:double pack rear frame	Length: 6.4m
Thickness: 1.2mm	Weight per meter: 0.74kg/m

Model: YDL-1651

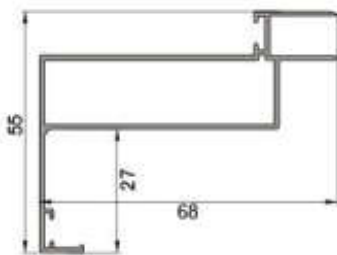

Name:double pack rear frame	Length: 6.4m
Thickness: 1.1mm	Weight per meter: 0.673kg/m

Model: YDL-19098

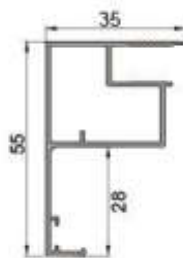

Name:wrapping hemming	Length: 6.4m
Thickness: 1.1mm	Weight per meter: 0.514kg/m

Model: YDL-19081

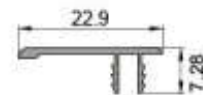

Name: rear frame F slot	Length: 6.4m
Thickness: 1.0mm	Weight per meter: 0.092kg/m

Model: YDL-19080

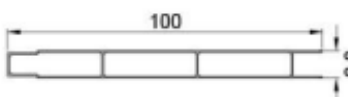

Name:gusset board	Length: 6.3m
Thickness: 0.55mm	Weight per meter: 0.35kg/m

Model: YDL-8306C

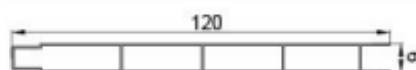

Name:gusset board	Length: 6.3m
Thickness: 0.6mm	Weight per meter: 0.457kg/m

Model: YDL-041



Name:gusset board	Length: 6.3m
Thickness: 0.6mm	Weight per meter: 0.48kg/m



Model: GD-6101

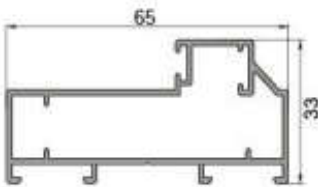

Name:frame	Length: 6.4m
Thickness: 1.2mm	Weight per meter: 0.779kg/m

Model: GD-6102

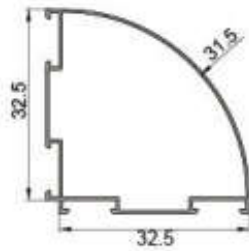

Name:corner	Length: 5.2m
Thickness: 1.0mm	Weight per meter: 0.793kg/m

Model: GD-6103

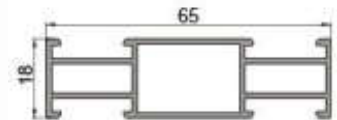

Name:middle frame	Length: 6.4m
Thickness: 1.2mm	Weight per meter: 0.694kg/m

Model: GD-6104

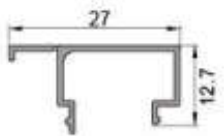

Name:pressing line	Length: 6.4m
Thickness: 0.9mm	Weight per meter: 0.147kg/m

Color:



Angel White



Pearl White



Porcelain Silver Color



Moonlight Grey



Black Color



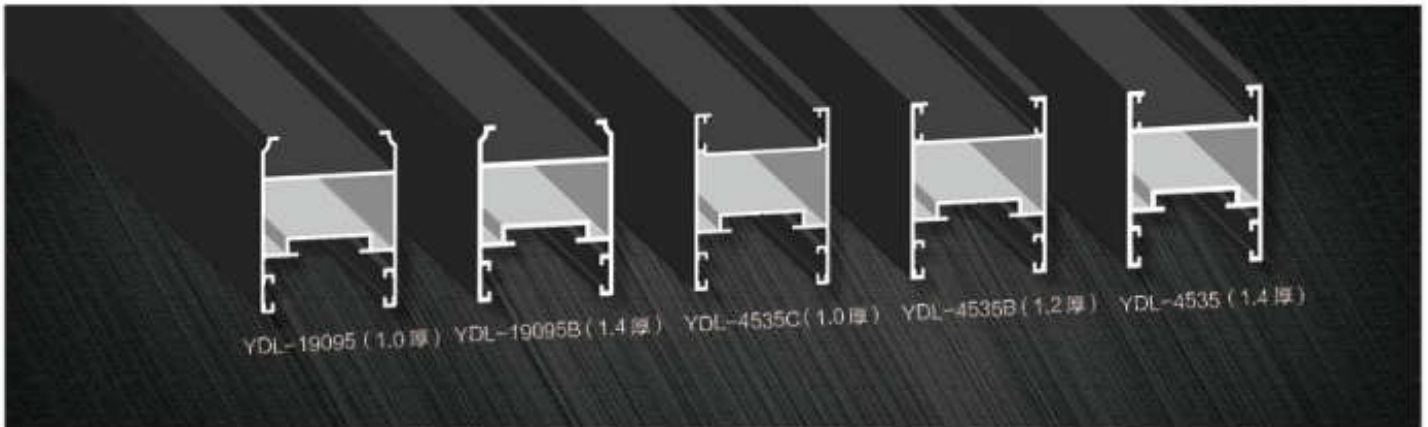

Model: GD-19095

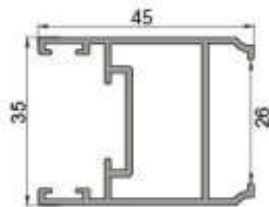

Name: flat section	Length: 6.3m
Thickness: 1.4mm	Weight per meter: 0.673kg/m

Model: YDL-19095B

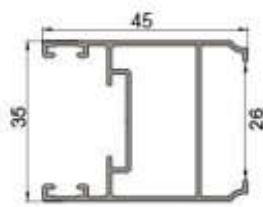

Name: flat section	Length: 6.3m
Thickness: 1.0mm	Weight per meter: 0.52kg/m

Model: YDL-4535

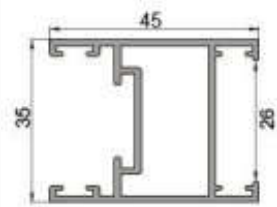

Name: flat section	Length: 6.3m
Thickness: 1.4mm	Weight per meter: 0.73kg/m

Model: YDL-4535B

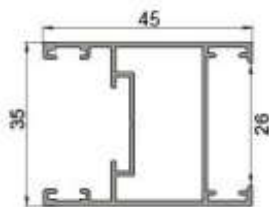

Name: flat section	Length: 6.3m
Thickness: 1.2mm	Weight per meter: 0.556kg/m

Model: YDL-4535C

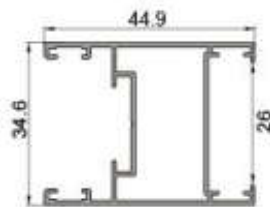

Name: flat section	Length: 6.3m
Thickness: 1.0mm	Weight per meter: 0.489kg/m

Model: YDL-046

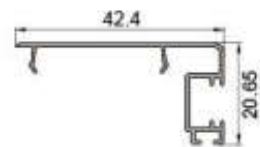

Name: hook section	Length: 4.8m
Thickness: 0.9mm	Weight per meter: 0.233kg/m

Model: YDL-301

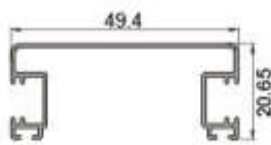

Name: double hook section	Length: 4.8m
Thickness: 0.8mm	Weight per meter: 0.266kg/m

Model: YDL-118

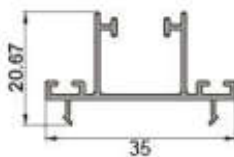

Name: sealing gap	Length: 4.8m
Thickness: 1.0mm	Weight per meter: 0.264kg/m





COLOR:



Cream Gray



Phantom Gray



Angel White



Pearl White



Enamel White



Porcelain Gray



Black Crystal Color



Black Color



Silver Gray



Wooden Color



Khaki Brown



Crystal Champagne Color



Crystal White



Forest Wood Color



Walnut Color



Red Wood

Model: YDL-19091

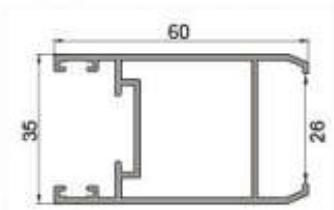

Name: flat section	Length: 6.3m
Thickness: 1.4mm	Weight per meter: 0.796kg/m

Model: YDL-19091B

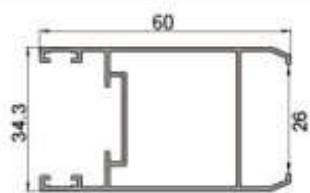

Name: flat section	Length: 6.3m
Thickness: 1.0mm	Weight per meter: 0.605kg/m

型号: YDL-19091C

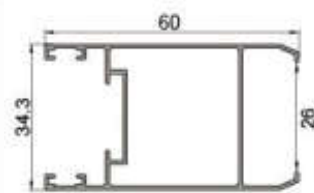

Name: flat section	Length: 6.3m
Thickness: 0.9mm	Weight per meter: 0.545kg/m

Model: YDL-19093



Name: hook section	Length: 4.8m
Thickness: 0.9mm	Weight per meter: 0.218kg/m

Model: YDL-19069

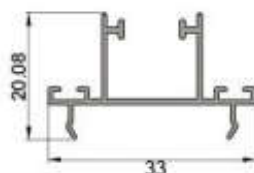

Name: sealing closure	Length: 4.8m
Thickness: 0.9mm	Weight per meter: 0.225kg/m



Model: YDL-6537

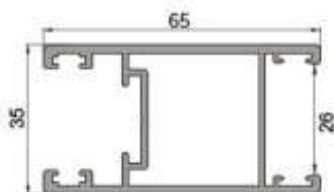

Name: flat section	Length: 6.3m
Thickness: 2.0mm	Weight per meter: 1.12kg/m

Model: YDL-6538

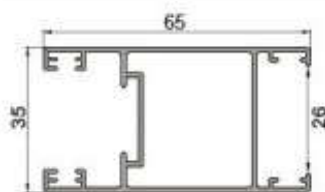

Name: flat section	Length: 6.3m
Thickness: 1.2mm	Weight per meter: 0.782kg/m

Model: YDL-6539

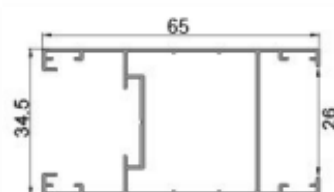

Name: flat section	Length: 6.3m
Thickness: 0.75mm	Weight per meter: 0.515kg/m

Model: YDL-6536B

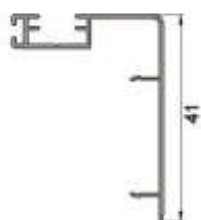

Name: hook section	Length: 4.8m
Thickness: 0.8mm	Weight per meter: 0.219kg/m

Model: YDL-6536S

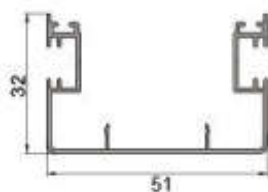

Name: double hook section	Length: 4.8m
Thickness: 1.0mm	Weight per meter: 0.463kg/m

Model: YDL-8665A

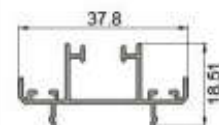

Name: sealing closure	Length: 4.8m
Thickness: 0.9mm	Weight per meter: 0.231kg/m

Model: YDL-19071

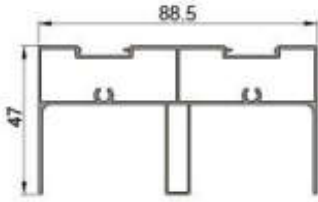

Name: double upper track Length: 6m
Thickness: 1.1mm Weight per meter: 0.911kg/m

Model: YDL-020

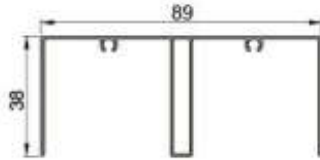

Name: single upper track Length: 6m
Thickness: 1.0mm Weight per meter: 0.643kg/m

Model: YDL-19070

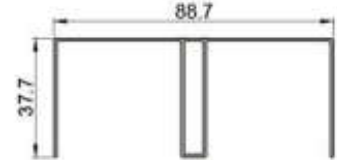

Name: single upper track Length: 6m
Thickness: 1.0mm Weight per meter: 0.659kg/m

Model: YDL-19073

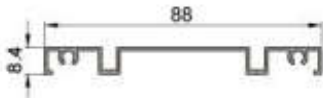

Name: steel lower rail Length: 6m
Thickness: 1.0mm Weight per meter: 0.435kg/m

Model: YDL-19072

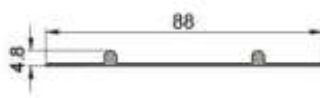

Name: lower rail Length: 6m
Thickness: 0.9mm Weight per meter: 0.29kg/m

Model: YDL-19074

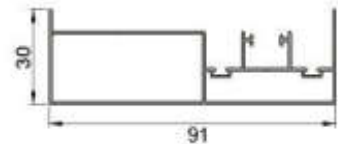

Name: double side seal Length: 4.8m
Thickness: 0.8mm Weight per meter: 0.631kg/m

Model: YDAL-8052

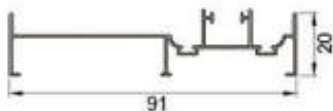

Name: single layer double side seal Length: 4.8m
Thickness: 0.8mm Weight per meter: 0.442kg/m

Model: YDL-19083

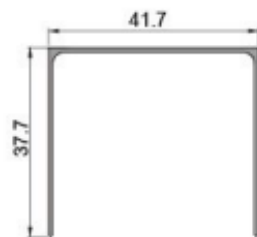

Name: single upper rail Length: 6m
Thickness: 0.8mm Weight per meter: 0.28kg/m

Model: YDL-19075



Name: single lower rail Length: 6m
Thickness: 1.0mm Weight per meter: 0.172kg/m

Model: YDL-19076

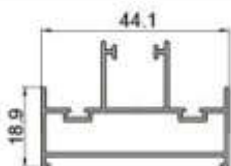

Name: single side seal Length: 4.8m
Thickness: 1.0mm Weight per meter: 0.45kg/m

Model: YDL-19067 Thickness: 0.8mm
Name: bright window Weight per meter: 0.646kg/m

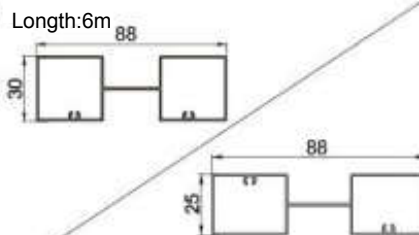

Length: 6m
Name: YDL-19077 Thickness: 0.7mm
Name: bright window Weight per meter: 0.53kg/m

Model: YDL-8705

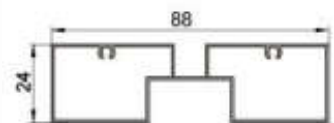

Name: bright window Length: 6m
Thickness: 0.8mm Weight per meter: 0.583kg/m

Model: YDL-8634A

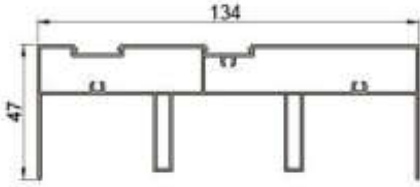

Name: three upper rail Length: 6m
Thickness: 1.0mm Weight per meter: 1.457kg/m

Model:YDL-8217

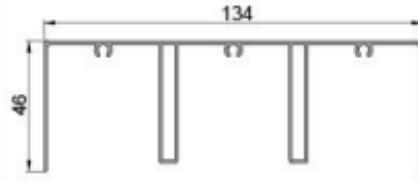

Name:three upper track Length:6m
Thickness:1.2mm Weight per meter: 1.3kg/m

Model: YDL-8218



Name:three side seal Length:4.8m
Thickness:1.2mm Weight per meter:1.3kg/m

Model:AXL-74

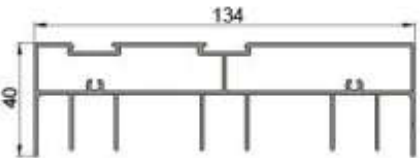

Name:three upper track Length:6m
Thickness:1.2mm Weight per meter:1.6kg/m

Model:AXL-75

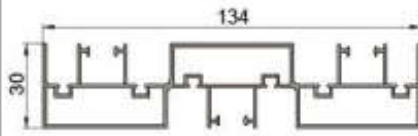

Name:three side seal Length:4.8m
Thickness:0.8mm Weight per meter:1.59kg/m

Model:AXL-76

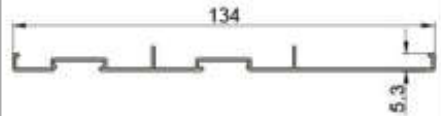

Name: side sealing cover plate Length:4.8m
Thickness:0.8mm Weight per meter: 0.39kg/m

Model:YDL-8519

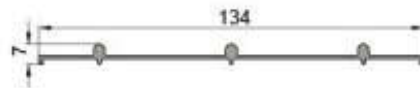

Name:three lower track Length:6m
Thickness:1.3mm Weight per meter:0.617kg/m

Model: YDL-8636A

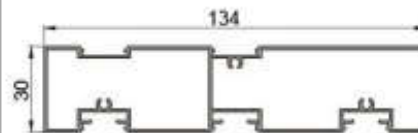

Name:side seal bright window Length:6m
Thickness: 1.1mm Weight per meter: 1.32kg/m

Model: YDL-8076

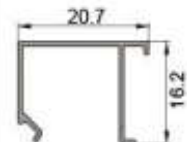

Name:bright window
pressure line Length: 6m
Thickness: 0.7mm Weight per meter: 0.109kg/m

Model: YDL-8637

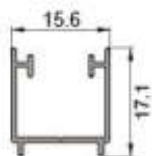

Name:lock slot Length: 4.8m
Thickness: 0.9mm Weight per meter: 0.139kg/m

Model: YDL-19098

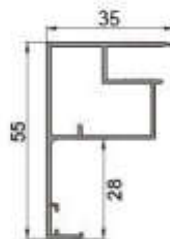

Name:wrapping hemming Length: 6.4m
Thickness: 1.1mm Weight per meter: 0.514kg/m

Model: YDL-19082

Name:single pack P slot Length: 0.8m
Weight per meter: 0.109kg/m

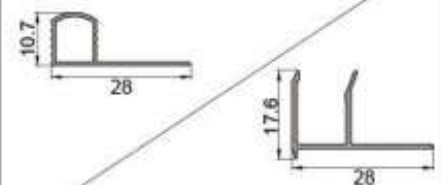

Model: YDL-19079 Thickness: 1.0mm
Name:double pack F slot Weight per meter: 0.156kg/m



COLOR:



Cream Gray



Phantom Gray



Angel White



Pearl White



Enamel White



Porcelain Gray



Black Crystal Color



Black Color



Silver Gray



Wood Color



Khaki Brown



Crystal Champagne Color

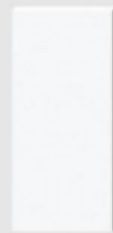

Crystal White



Forest Wood Color



Walnut Color



Red Wood

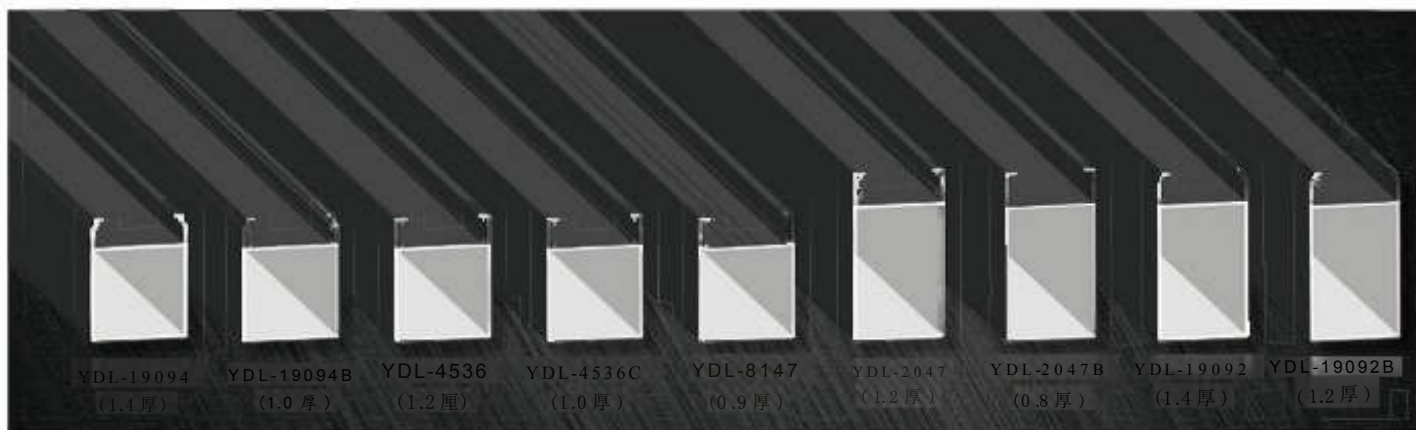

Model: YDL-19094

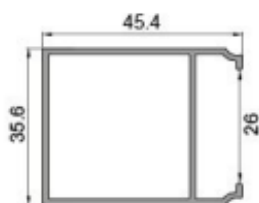

Name: flat section	Length: 6.2m
Thickness: 1.4mm	Weight per meter: 0.574kg/m

Model: YDL-19094B

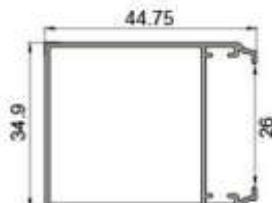

Name: flat section	Length: 6.2m
Thickness: 1.0mm	Weight per meter: 0.438kg/m

Model: YDL-4536

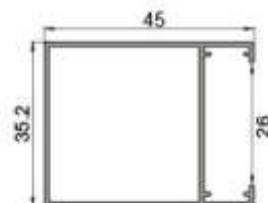

Name: flat section	Length: 6.2m
Thickness: 1.2mm	Weight per meter: 0.498kg/m

Model: YDL-4536C

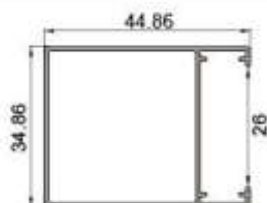

Name: flat section	Length: 6.2m
Thickness: 1.0mm	Weight per meter: 0.426kg/m

Model: YDL-8147

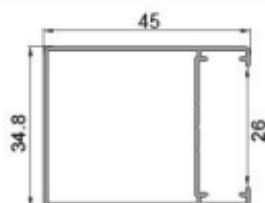

Name: flat section	Length: 6.2m
Thickness: 0.9mm	Weight per meter: 0.406kg/m

Model: YDL-2047



Name: flat section	Length: 6.2m
Thickness: 1.2mm	Weight per meter: 0.655kg/m

Model: YDL-2047B

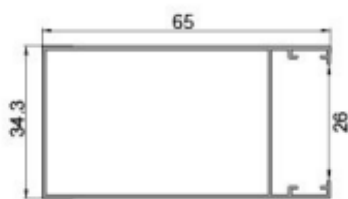

Name: flat section	Length: 6.2m
Thickness: 0.8mm	Weight per meter: 0.465kg/m

Model: YDL-19092



Name: flat section	Length: 6.2m
Thickness: 1.4mm	Weight per meter: 0.713kg/m

Model: YDL-19092B



Name: flat section	Length: 6.2m
Thickness: 1.2mm	Weight per meter: 0.65kg/m

Model: YDL-3501

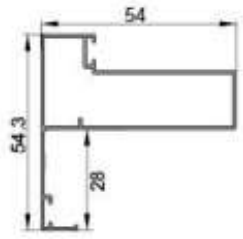

Name: front wrapping	Length: 6.4m
Thickness: 0.8mm	Weight per meter: 0.472kg/m

Model: YDL-3502

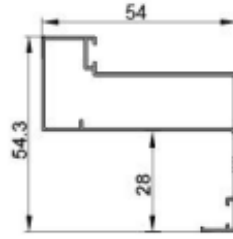

Name: reverse package	Length: 6.4m
Thickness: 0.8mm	Weight per meter: 0.472kg/m

Model: YDL-3503

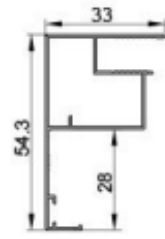

Name: front frame	Length: 6.4m
Thickness: 0.8mm	Weight per meter: 0.392kg/m

Model: YDL-3504

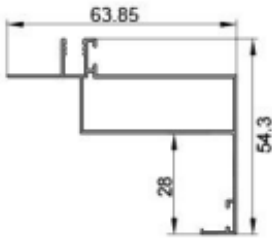

Name: back frame	Length: 6.4m
Thickness: 0.8mm	Weight per meter: 0.479kg/m

Model: YDL-3505

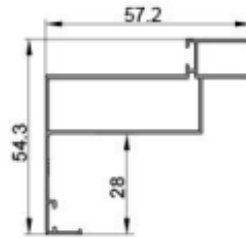

Name: back frame	Length: 6.4m
Thickness: 0.8mm	Weight per meter: 0.465kg/m

Model: YDL-19096F

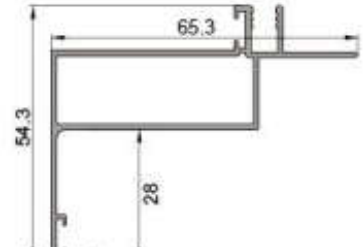

Name: double pack rear frame	Length: 6.4m
Thickness: 1.1mm	Weight per meter: 0.628kg/m

Model: YDL-19096

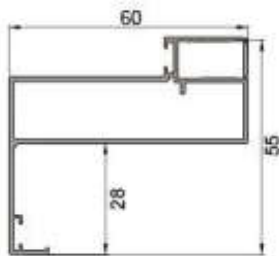

Name: reverse back frame	Length: 6.4m
Thickness: 1.1mm	Weight per meter: 0.715kg/m

Model: YDL-19097

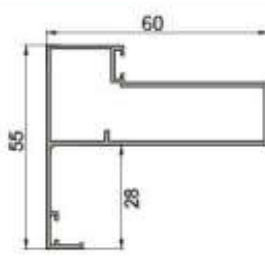

Name: front wrapping	Length: 6.4m
Thickness: 1.1mm	Weight per meter: 0.672kg/m

Model: YDL-19098

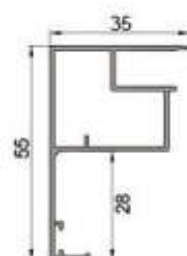

Name: wrapping hemming	Length: 6.4m
Thickness: 1.1mm	Weight per meter: 0.514kg/m

Model: YDL-2249

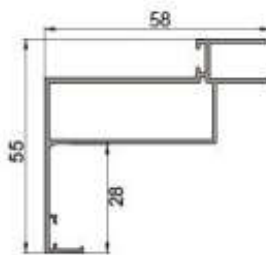

Name: double pack rear frame	Length: 6.4m
Thickness: 1.1mm	Weight per meter: 0.627kg/m

Model: YDL-3510

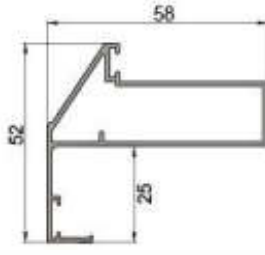

Name: front wrapping	Length: 6.4m
Thickness: 1.2mm	Weight per meter: 0.67kg/m

Model: YDL-3512

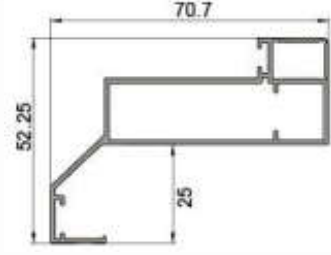

Name: reverse back frame	Length: 6.4m
Thickness: 1.2mm	Weight per meter: 0.758kg/m

Model: YDL-3511

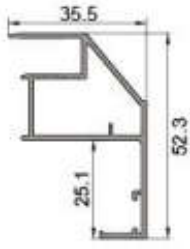

Name: front wrapping Length: 6.4m
Thickness: 1.2mm Weight per meter:
0.523kg/m

Model: YDL-2048

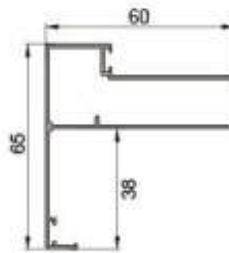

Name: front wrapping Length: 6.4m
Thickness: 1.1mm Weight per meter:
0.692kg/m

Model: YDL-2049

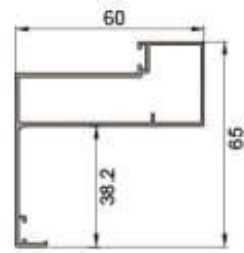

Name: reverse package Length: 6.4m
Thickness: 1.1mm Weight per meter:
0.656kg/m

Model: YDL-2050

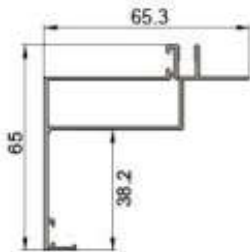

Name: back frame Length: 6.4m
Thickness: 1.1mm Weight per meter:
0.65kg/m

Model: YDL-2051

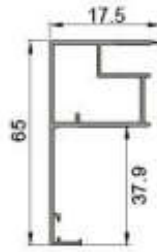

Name: front frame Length: 6.4m
Thickness: 1.1mm Weight per meter:
0.55kg/m

型号: YDL-2048B

Model: YDL-2048B

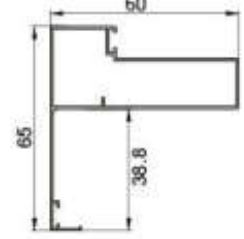

Name: front wrapping Length: 6.4m
Thickness: 0.8mm Weight per meter:
0.511kg/m

Model: YDL-2049B

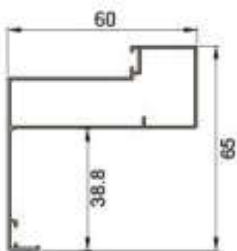

Name: reverse package Length: 6.4m
Thickness: 0.8mm Weight per meter:
0.511kg/m

Model: YDL-2050B

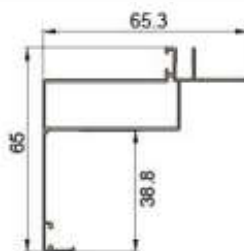

Name: back frame Length: 6.4m
Thickness: 0.8mm Weight per meter:
0.488kg/m

Model: YDL-2051B

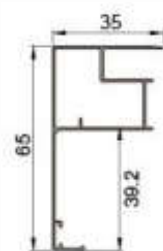

Name: front frame Length: 6.4m
Thickness: 0.8mm Weight per meter:
0.41kg/m

Model: YDL-19081



Name: rear frame F slot Length: 6m
Thickness: 1.0mm Weight per meter:
0.092kg/m

Model: YDL-19080

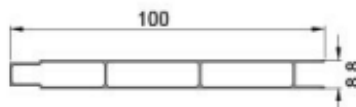

Name: gusset board Length: 6.3m
Thickness: 0.55mm Weight per meter:
0.35kg/m

Model: YDL-041 Thickness: 0.6mm
Name: gusset board Weight per meter: 0.48kg/m
Length: 6.3m

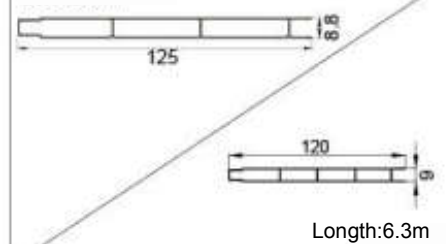

Model: YDL-8306C Thickness: 0.6mm
Name: gusset board Weight per meter:
0.457kg/m

Model: YDL-2201B

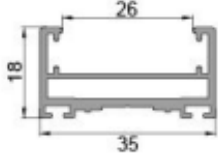

Name: flat section	Length: 6.4m
Thickness: 1.5mm	Weight per meter: 0.443kg/m

Model: YDL-2201

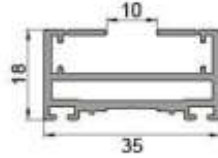

Name: flat section	Length: 6.4m
Thickness: 1.5mm	Weight per meter: 0.526kg/m

Model: YDL-2202

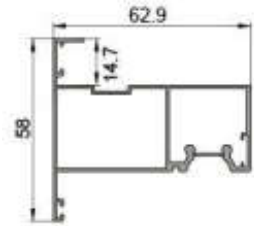

Name: positive edge wrap frame	Length: 6.4m
Thickness: 1.1mm	Weight per meter: 0.8kg/m

Model: YDL-2203

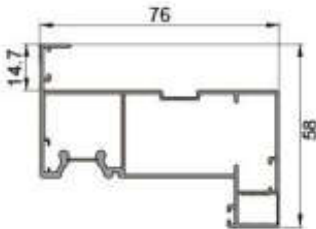

Name: reverse edge wrap frame	Length: 6.4m
Thickness: 1.1mm	Weight per meter: 0.97kg/m

Model: YDL-2208

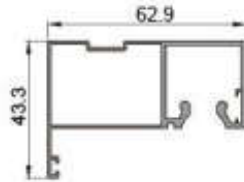

Name: frame	Length: 6.4m
Thickness: 1.1mm	Weight per meter: 0.769kg/m

Model: YDL-2208A

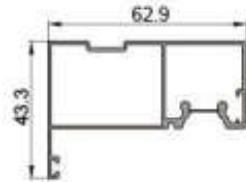

Name: frame	Length: 6.4m
Thickness: 1.1mm	Weight per meter: 0.724kg/m

Model: YDL-2204

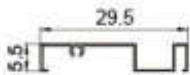

Name: lower track	Length: 6m
Thickness: 1.0mm	Weight per meter: 0.297kg/m

Color:



Pearl White



Flat Gray



Black Color



Moonlight Grey



Cream Grey



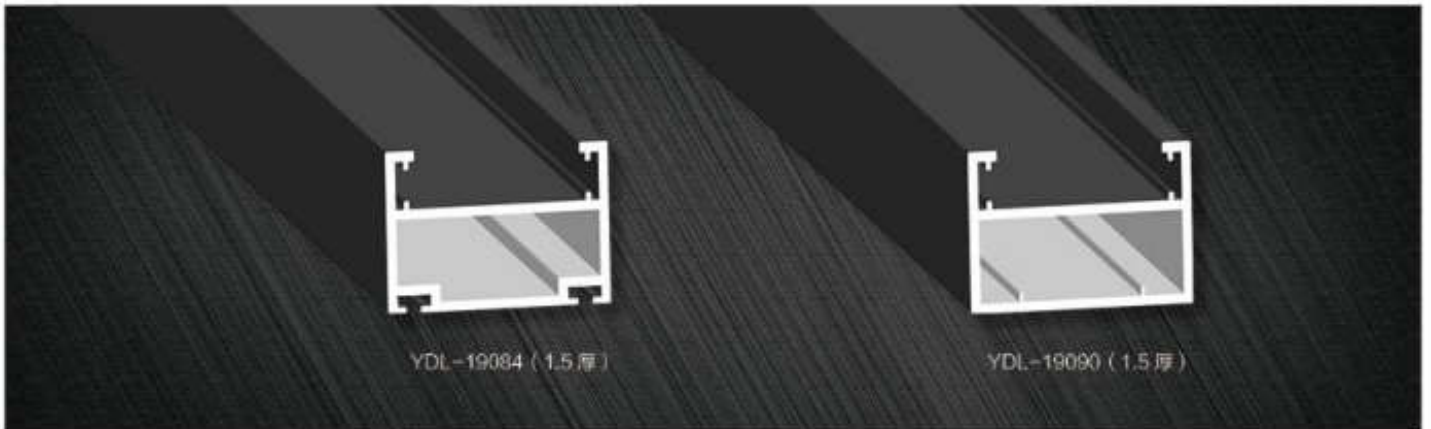

YDL-19084 (1.5厚)

YDL-19090 (1.5厚)

Model: YDL-19084

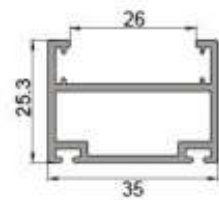

Name, flat section	Length: 5.3m
Thickness: 1.5mm	Weight per meter: 0.546kg/m

Model: YDL-19086

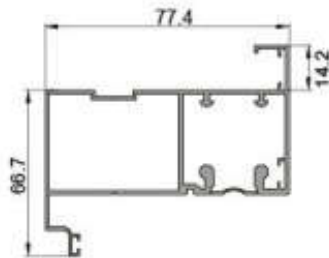

Name, reverse side encirclement	Length: 6.4m
Thickness: 1.2mm	Weight per meter: 0.12kg/m

Model: YDL-19088

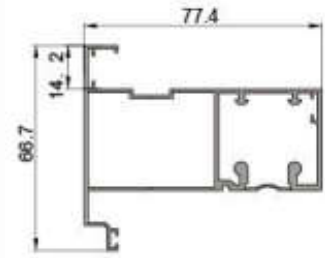

Name, frontal surround	Length: 6.4m
Thickness: 1.2mm	Weight per meter: 1.235kg/m

Model: YDL-19089

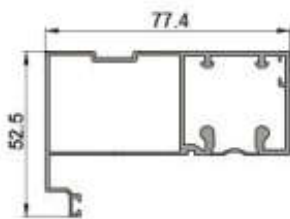

Name, frame	Length: 6.4m
Thickness: 1.2mm	Weight per meter: 1.147kg/m

Model: YDL-19087

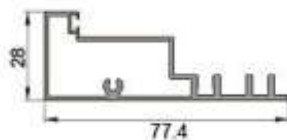

Name, lower track	Length: 6m
Thickness: 1.0mm	Weight per meter: 0.788kg/m

Model: YDL-19085

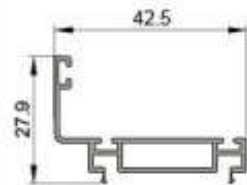

Name, closure	Length: 4.8m
Thickness: 1.0mm	Weight per meter: 0.357kg/m

Model: YDL-19090

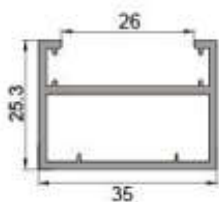

Name, flat section	Length: 6.4m
Thickness: 1.5mm	Weight per meter: 0.505kg/m

Model: YDL-19099

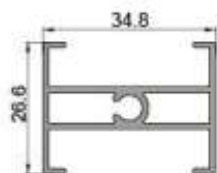

Name, middle horizontal	Length: 6m
Thickness: 1.1mm	Weight per meter: 0.44kg/m

Color:

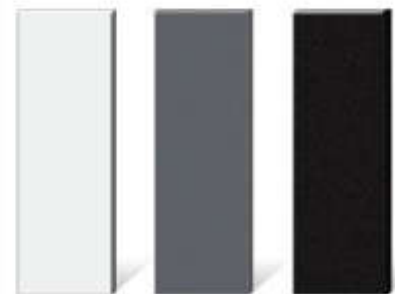

Pearl White

Flat Grey

Black Color

Model: YDL-2242

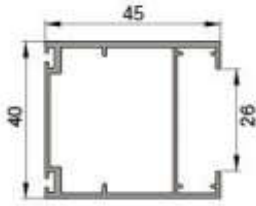

Name: flat section	Length: 6m
Thickness: 1.4mm	Weight per meter: 0.686kg/m

Model: YDL-2239

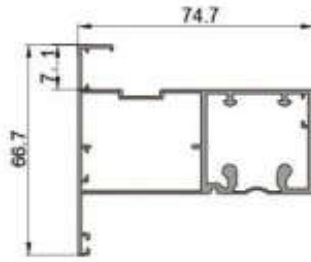

Name: frontal surround	Length: 6.4m
Thickness: 1.1mm	Weight per meter: 1.236kg/m

Model: YDL-2240

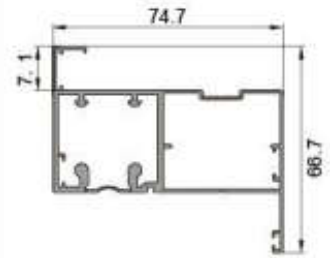

Name: reverse side encirclement	Length: 6.4m
Thickness: 1.1mm	Weight per meter: 1.236kg/m

Model: YDL-2241

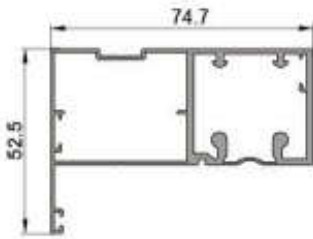

Name: frame	Length: 6.4m
Thickness: 1.1mm	Weight per meter: 1.16kg/m

Model: YDL-2243

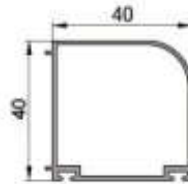

Name: corner	Length: 4.8m
Thickness: 1.1mm	Weight per meter: 0.525kg/m

Model: YDL-2244

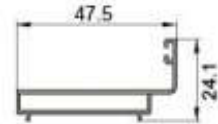

Name: closure	Length: 4.8m
Thickness: 1.0mm	Weight per meter: 0.332kg/m

Model: YDL-2245

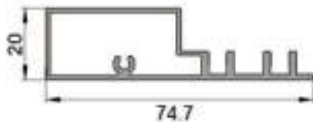

Name: lower track	Length: 6m
Thickness: 1.2mm	Weight per meter: 0.717kg/m

Color:



porcelain silver gray



black color



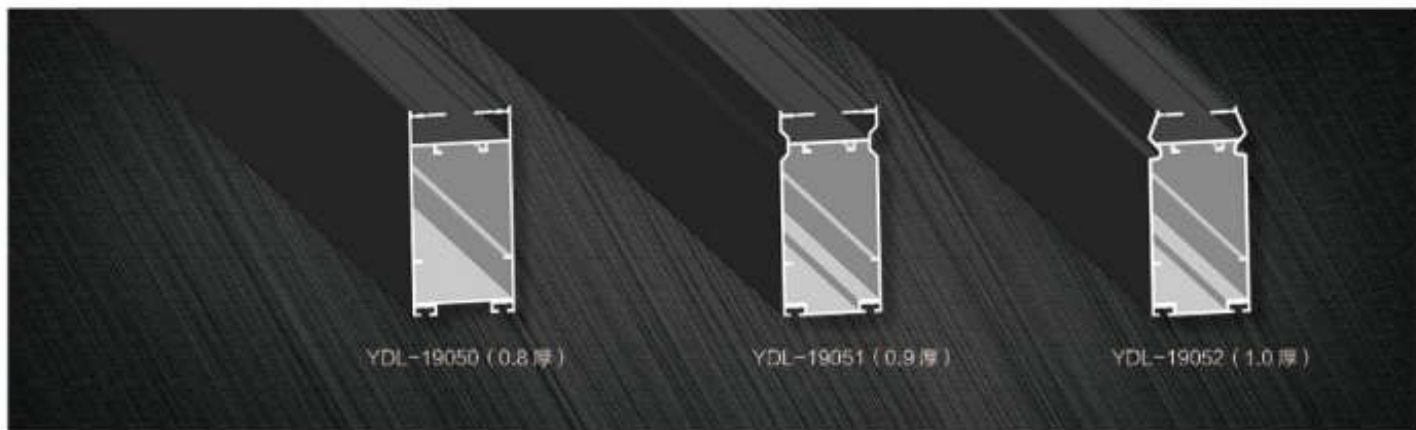

YDL-19050 (0.8 厚)

YDL-19051 (0.9 厚)

YDL-19052 (1.0 厚)

Model: YDL-19050

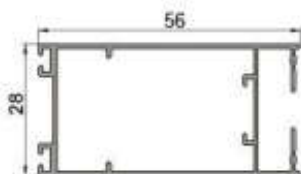

Name: flat section	Length: 6m
Thickness: 0.8mm	Weight per meter: 0.479kg/m

Model: YDL-19051

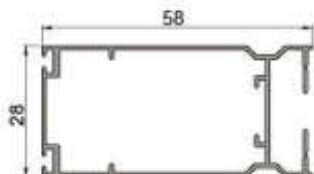

Name: flat section	Length: 5.2m
Thickness: 0.9mm	Weight per meter: 0.524kg/m

型号: YDL-19052

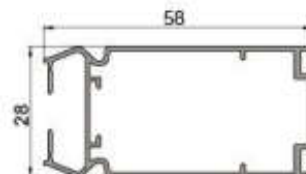

Name: flat section	Length: 5.2m
Thickness: 1.0mm	Weight per meter: 0.562kg/m

Model: YDL-19046

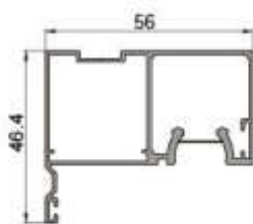

Name: frame	Length: 5.3m
Thickness: 1.0mm	Weight per meter: 0.716kg/m

Model: YDL-19047

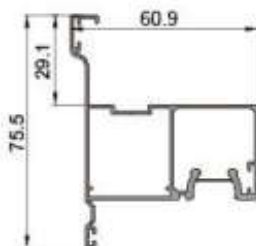

Name: front wrap frame	Length: 5.3m
Thickness: 1.0mm	Weight per meter: 0.843kg/m

Model: YDL-19048

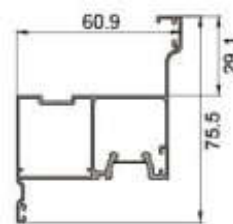

Name: reverse wrapping frame	Length: 5.3m
Thickness: 1.0mm	Weight per meter: 0.843kg/m

Model: YDL-19049

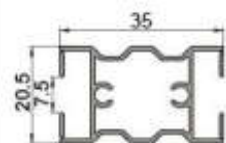

Name: middle frame	Length: 6m
Thickness: 0.9mm	Weight per meter: 0.352kg/m

Model: YDL-19053



Name: lower track	Length: 6m
Thickness: 1.0mm	Weight per meter: 0.276kg/m

Model: YDL-20215

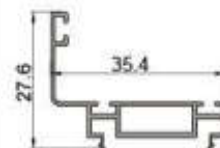

Name: sealing closure	Length: 4.8m
Thickness: 0.8mm	Weight per meter: 0.256kg/m



Focus on quality and high appearance,
make life different

Color:



Crystal White



Crystal Champagne Color



Black Color



Red Wood



Aluminum alloy one-piece molding and frame cover

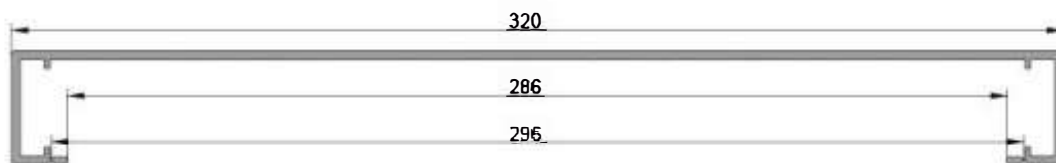

Model: YDL-836

Thickness: 2.8mm

Weight per meter: 2.957kg/m

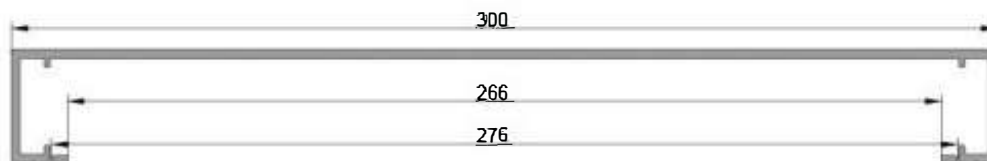

Model: YDL-837

Thickness: 2.8mm

Weight per meter: 2.815kg/m

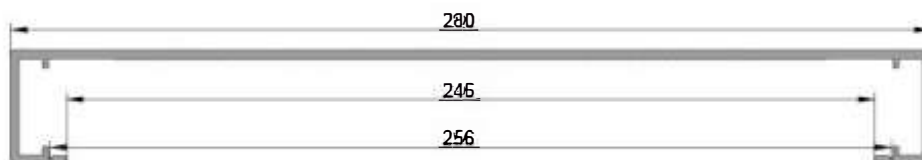

Model: YDL-838

Thickness: 2.8mm

Weight per meter: 2.6kg/m

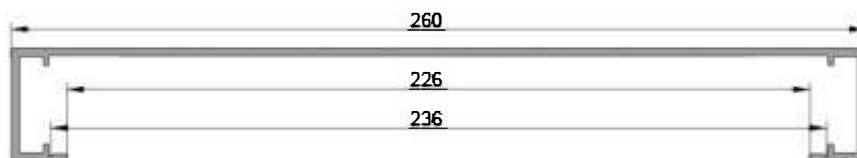

Model: YDL-839

Thickness: 2.6mm

Weight per meter: 2.353kg/m

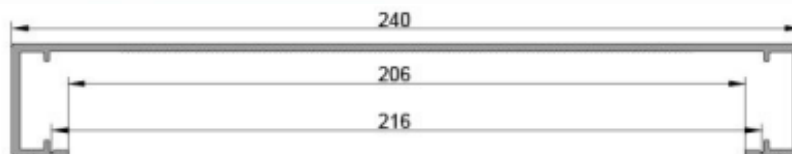

Model: YDL-840

Thickness: 2.4mm

Weight per meter: 2.22kg/m

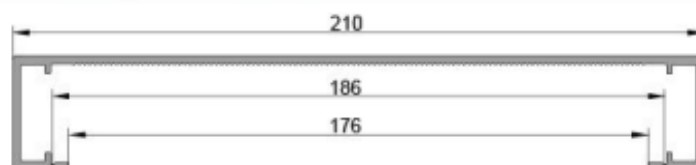

Model: YDL-841

Thickness: 2.4mm

Weight per meter: 2.0kg/m



FASHION DESIGN

|

Excellent workmanship

Customization

Zero formaldehyde



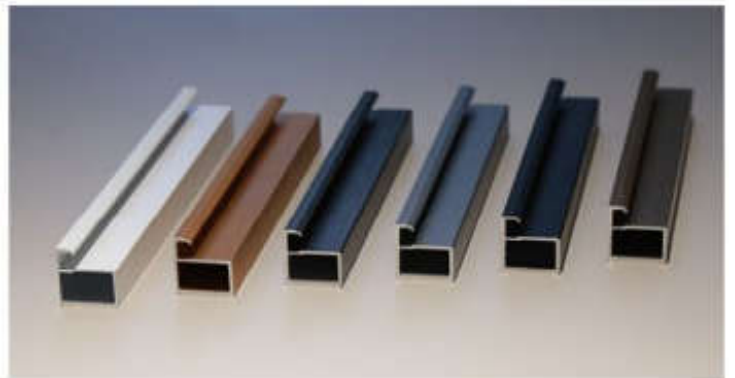
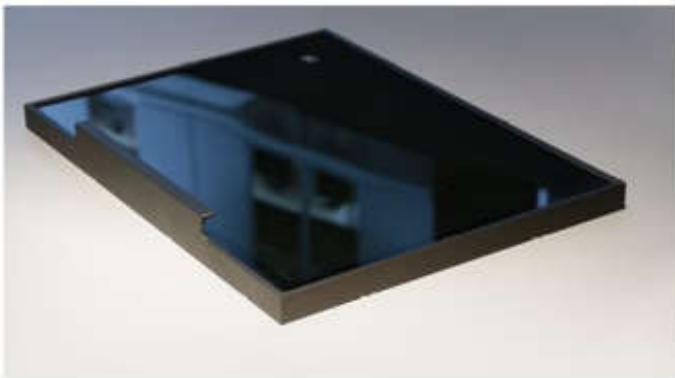



Minimalism is a form of beauty

Narrow frame glass cabinet door

Brings strong impact

Unobstructed sense of space

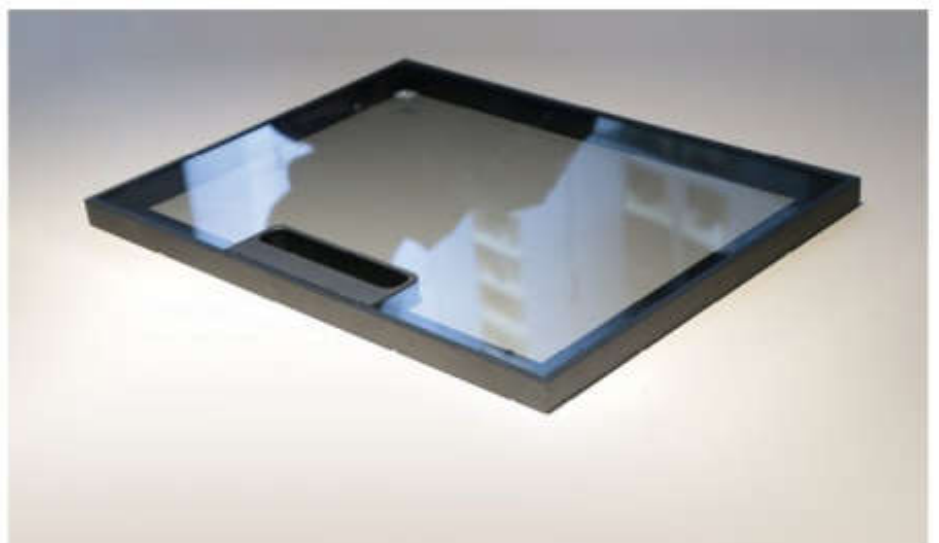

Model: YDL-1801

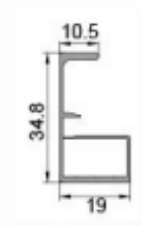

Name: handle frame	Length: 2.5m
Thickness: 1.7mm	Weight per meter: 0.284kg/m

Model: YDL-1802

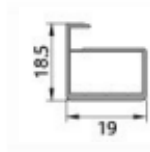

Name: frame	Length: 3.5m
Thickness: 1.7mm	Weight per meter: 0.192kg/m

Model: YDL-2025

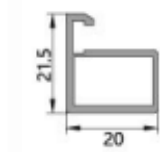

Name: frame	Length: 3.5m /6m
Thickness: 1.8mm	Weight per meter: 0.284kg/m

Model: YDL-4416

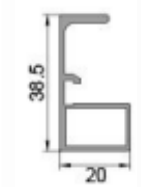

Name: handle frame	Length: 2.5m/2.9m
Thickness: 1.8mm	Weight per meter: 0.426kg/m

Model: ZSM-01

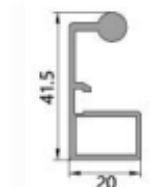

Name: handle frame	Length: 2.5m
Thickness: 1.8mm	Weight per meter: 0.446kg/m

Model: ZSM-10

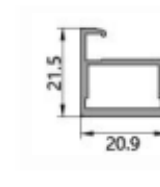

Name: frame	Length: 3.5m
Thickness: 2.0mm	Weight per meter: 0.321kg/m

Model: ZSM-11



Name: frame	Length: 2.5m
Thickness: 2.0mm	Weight per meter: 0.321kg/m

Model: YDL-211



Name: frame	Length: 3.5m
Thickness: 2.0mm	Weight per meter: 0.321kg/m

Model: YDL-212

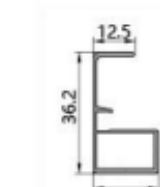

Name: handle frame	Length: 2.5m
Thickness: 1.5mm	Weight per meter: 0.292kg/m

Model: ZSM-15

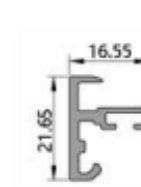

Name: frame	Length: 3.3m
Thickness: 2.0mm	Weight per meter: 0.245kg/m

Model: ZSM-16

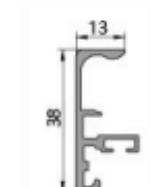

Name: handle frame	Length: 3m
Thickness: 2.0mm	Weight per meter: 0.369kg/m

New lightluxury

The extension of simple lines, the collision of bold color blocks, this is the concept of refinement and luxury conveyed by the new light luxury.

<p>Fig.1 2.5m middle 200 handle</p>	<p>Fig.2 2.5 meters down 1.1 meters long handle (left)</p>	<p>Fig.3 2.5m down 1.1m long handle (right)</p>	<p>Fig.4 1.25 meters below, middle control hand 200</p>	<p>Fig.5 833 middle handle 160</p>	<p>Fig.6 500 middle handle 160</p>		
<p>Fig.1 2.5m middle 200 handle</p> <p>1.8/2.0 thickness handle position</p>	<p>Fig.2 2.5m down 1.1m long handle (left)</p> <p>1.8/2.0 thickness handle position</p>	<p>Fig.3 2.5m down 1.1m long handle (right)</p> <p>1.8/2.0 thickness handle position</p>	<p>Fig.4 1.25 meters below, mid-threshold handle 200</p> <p>1.8/2.0 thickness handle position</p>	<p>Fig.5 833 middle handle 160</p> <p>1.8/2.0 thickness handle position</p>	<p>Fig.6 500 middle handle 160</p> <p>1.8/2.0 thickness handle position</p>		
<p>Fig.1 2.9m lower 1.1m long handle (left)</p>	<p>Fig.2 2.9m lower 1.1m long handle (right)</p>	<p>Fig.3 2.9m down 1.35m 200 handle (right)</p>	<p>Fig.4 2.9m down 1.35m 200 handle (left)</p>	<p>Fig.5 1.45m middle handle 200</p>	<p>Fig.6 966 middle handle 160</p>		
<p>Fig.1 3m 200 short handle (left)</p> <p>Punch-free handle position</p>	<p>Fig.2 3m 200 short handle (right)</p> <p>Punch-free handle position</p>	<p>Fig.3 3m 1100 long handle (left)</p> <p>Punch-free handle position</p>	<p>Fig.4 3m 1100 long handle (right)</p> <p>Punch-free handle position</p>	<p>Fig.5 3 meters down 200 two sections center press</p> <p>Punch-free handle position</p>	<p>Fig.6 3 meters down 200 three sections center press</p> <p>Punch-free handle position</p>	<p>Fig.7 3 meters down 200 four sections center press</p> <p>Punch-free handle position</p>	<p>Fig.8 3 meters down 200 five sections center press</p> <p>Punch-free handle position</p>

Warm reminder:

1. The size of the picture may be slightly different from the actual product. The company has the right to modify or cancel the above products without prior notice.
2. Please contact the manufacturer for confirmation of the specific size data of the project.
3. Due to printing, the color of the official product is slightly different from the picture shown. All is subject to the actual product.

ADDRESS: Yadanli Factory, No. 10, Industrial Zone 2, Songgang Avenue, Shishan Town
, Nanhai District, Foshan City